

600888-GB

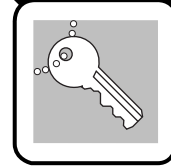

A Textron Company



OWNER'S MANUAL AND SERVICE GUIDE

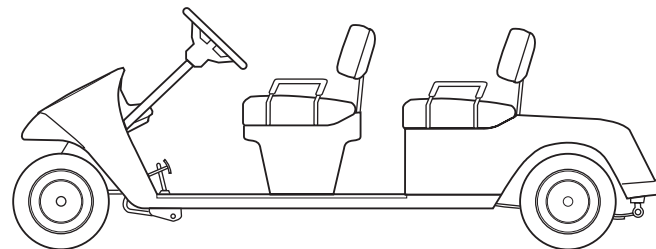
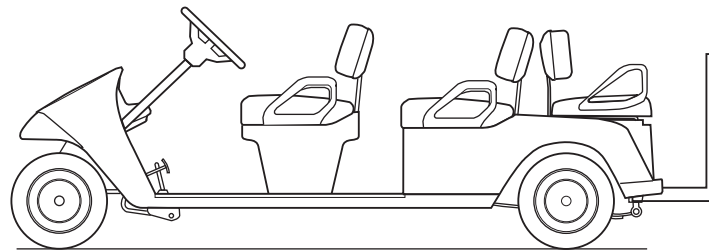
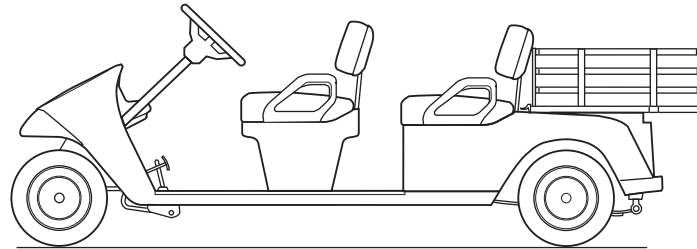
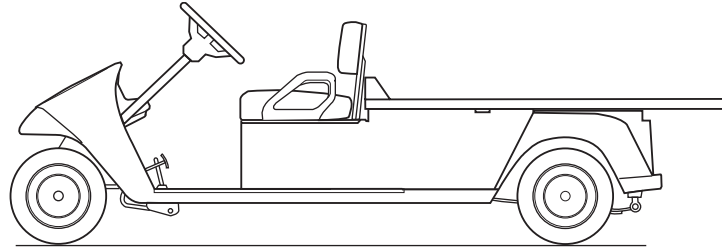

GASOLINE POWERED PERSONNEL CARRIERS AND GOLF CAR

ISSUED APRIL 2005

SAFETY

For any questions on material contained in this manual, contact an authorized representative for clarification.

Read and understand all labels located on the vehicle. Always replace any damaged or missing labels.

On steep hills it is possible for vehicles to coast at greater than normal speeds encountered on a flat surface. To prevent loss of vehicle control and possible serious injury, speeds should be limited to no more than the maximum speed on level ground. See GENERAL SPECIFICATIONS. Limit speed by applying the service brake.

Catastrophic damage to the drivetrain components due to excessive speed may result from driving the vehicle above specified speed. Damage caused by excessive speed may cause a loss of vehicle control, is costly, is considered abuse and will not be covered under warranty.

For moving/transporting vehicle, refer to "TRANSPORTING VEHICLE".

Signs similar to the ones illustrated should be used to warn of situations that could result in an unsafe condition.

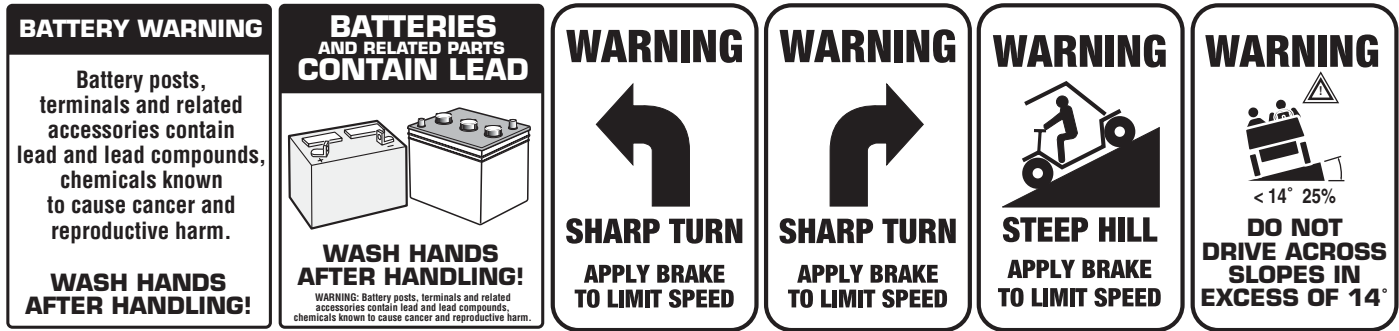

Be sure that this manual remains as part of the permanent service record should the vehicle be sold.

NOTES, CAUTIONS AND WARNINGS

Throughout this guide **NOTE**, **CAUTION** and **WARNING** will be used.

NOTE A **NOTE** indicates a condition that should be observed.

CAUTION A **CAUTION** indicates a condition that may result in damage to the vehicle.

WARNING A **WARNING** indicates a hazardous condition that could result in severe injury or death.

Observe these **NOTES**, **CAUTIONS** and **WARNINGS**; be aware that servicing a vehicle requires mechanical skill and a regard for conditions that could be hazardous. Improper service or repair may damage the vehicle or render it unsafe.

WARNING Engine exhaust from this product contains chemicals known, in certain quantities, to cause cancer, birth defects, or other reproductive harm.

NOTE The exhaust emissions of this vehicles' engine complies with regulations set forth by the Environmental Protection Agency (EPA) of the United States of America (USA) at time of manufacture. Significant fines could result from modifications or tampering with the engine, fuel, ignition or air intake systems.

WARNING Battery posts, terminals and related accessories contain lead and lead compounds. Wash hands after handling.

NOTE This spark ignition system meets all requirements of the Canadian Interference-Causing Equipment Regulations.

Ce système d'allumage par étincelle de véhicule respecte toutes les exigences du Règlement sur le matériel brouilleur du Canada.

(NOTES, CAUTIONS AND WARNINGS CONTINUED ON INSIDE OF BACK COVER)

OWNER'S MANUAL AND SERVICE GUIDE

GASOLINE POWERED CARGO, PERSONNEL CARRIER AND GOLF CAR

VEHICLES

Shuttle 2

Shuttle 4

Shuttle 6

TG5

Starting Model Year 2005

E-Z-GO Division of TEXTRON, Inc. reserves the right to make design changes without obligation to make these changes on units previously sold and the information contained in this manual is subject to change without notice.

E-Z-GO Division of TEXTRON, Inc. is not liable for errors in this manual or for incidental or consequential damages that result from the use of the material in this manual.

TO CONTACT US

NORTH AMERICA:

TECHNICAL ASSISTANCE & WARRANTY PHONE: 1-800-774-3946, FAX: 1-800-448-8124

SERVICE PARTS PHONE: 1-888-GET-EZGO (1-888-438-3946), FAX: 1-800-752-6175

INTERNATIONAL:

PHONE: 010-1-706-798-4311, FAX: 010-1-706-771-4609

E-Z-GO DIVISION OF TEXTRON, INC., 1451 MARVIN GRIFFIN ROAD, AUGUSTA, GEORGIA USA 30906-3852

NOTES

This vehicle has been designed and manufactured in the United States of America (USA) as a 'World Vehicle'. The Standards and Specifications listed in the following text originate in the USA unless otherwise indicated.

The use of non Original Equipment Manufacturer (OEM) approved parts may void the warranty.

Overfilling battery may void the warranty.

Tampering with or adjusting the governor to permit vehicle to operate at above factory specifications will void the vehicle warranty.

When servicing engines, all adjustments and replacement components must be per original vehicle specifications in order to maintain the United States of America Federal and State emission certification applicable at the time of manufacture.

BATTERY PROLONGED STORAGE

All batteries will self discharge over time. The rate of self discharge varies depending on the ambient temperature and the age and condition of the batteries.

A fully charged battery will not freeze in winter temperatures unless the temperature falls below -75° F (-60° C).

TABLE OF CONTENTS

SAFETY	Inside covers
NOTES	ii
SAFETY INFORMATION	v
BEFORE INITIAL USE	1
<i>Fig. 1 Initial Service Chart</i>	1
CONTROLS AND INDICATORS	1
KEY/LIGHT SWITCH	1
<i>Fig. 2 Key/Light Switch, Low Oil Pressure Light and Fuel Gauge</i>	2
DIRECTION SELECTOR	2
<i>Fig. 3 Direction Selector</i>	2
CHOKE	2
<i>Fig. 4 Choke</i>	2
FUEL GAUGE	2
LOW OIL PRESSURE INDICATOR LIGHT	2
ACCELERATOR PEDAL	2
<i>Fig. 5 Accelerator and Brake Controls</i>	3
HORN	3
<i>Fig. 6 Horn Button</i>	3
OPERATING THE VEHICLE	3
RUN-IN	4
<i>Fig. 7 Check Oil Level on Dipstick</i>	4
COLD STARTING	4
STARTING AND DRIVING	4
STARTING THE VEHICLE ON A HILL	5
COASTING	5
FUEL	5
<i>Fig. 8 Fueling</i>	5
BATTERY	5
LABELS AND PICTOGRAMS	6
SUN TOP AND WINDSHIELD	6
VEHICLE CLEANING AND CARE	6
VEHICLE CLEANING	6
REPAIR	6
LIFTING THE VEHICLE	6
WHEELS AND TIRES	7
Tire Repair	7
<i>Fig. 9 Lifting the Vehicle</i>	7
Wheel Installation	8
LIGHT BULB REPLACEMENT	8
<i>Fig. 10 Wheel Installation</i>	8
<i>Fig. 11 Headlight, Turn Signal & Marker Light Bulb Replacement</i>	9
<i>Fig. 12 Tail and Brake Light Bulb Replacement</i>	9
FUSE REPLACEMENT	8
VEHICLE WITH A DISCHARGED BATTERY	8
TRANSPORTING VEHICLE	10
TOWING	10
NEUTRAL LOCK	10
<i>Fig. 13 Neutral Lock</i>	10
HAULING	10
SERVICE AND MAINTENANCE	10
SERIAL NUMBER PLATE LOCATION	11
PERIODIC SERVICE SCHEDULE	12
<i>Fig. 14 Periodic Service Schedule</i>	12
TIRE INSPECTION	14
CHECKING THE OIL LEVEL	14
<i>Fig. 15 Clean Entire Dipstick</i>	14

TABLE OF CONTENTS

<i>Fig. 16 Check Oil Level on Dipstick</i>	14
CHANGING THE OIL	14
<i>Fig. 17 Oil Viscosity Chart</i>	15
<i>Fig. 18 Clean Top of Engine</i>	15
<i>Fig. 19 Remove Oil Filter</i>	15
<i>Fig. 20 Clean Oil Filter</i>	15
<i>Fig. 21 Blowing Out Oil Filter</i>	16
<i>Fig. 22 Add Engine Oil</i>	16
STARTER/GENERATOR BELT TENSION	16
<i>Fig. 23 Checking Belt Tension with Gauge</i>	16
Adjusting the Belt	17
<i>Fig. 24 Checking Belt Tension Manually</i>	17
<i>Fig. 25 Adjusting Belt Tension</i>	17
BATTERY CLEANING	17
BRAKES	17
Periodic Brake Test for Mechanical Brakes	18
<i>Fig. 26 Preparing Acid Neutralizing Solution</i>	18
<i>Fig. 27 Typical Brake Performance Test</i>	18
HYDRAULIC FRONT DISC BRAKES (If Equipped)	19
AIR INTAKE AND COOLING FINS	19
<i>Fig. 28 Cleaning Air Intake</i>	19
<i>Fig. 29 Cleaning the Cooling Fins</i>	19
REAR AXLE	20
<i>Fig. 30 Add, Check and Drain Rear Axle Lubricant</i>	20
Checking the Lubricant Level	20
AIR CLEANER INSPECTION AND REPLACEMENT	20
<i>Fig. 31 Air Cleaner</i>	20
Cleaning the Air Filter Element	20
LUBRICATION	20
SPARK PLUGS	21
DIRECTION SELECTOR (Dual Cable system)	21
<i>Fig. 32 Lubrication Points</i>	21
<i>Fig. 33 Shift Cable Adjustment</i>	21
PROLONGED STORAGE	21
HARDWARE	22
<i>Fig. 34 Torque Specifications</i>	22
CAPACITIES AND REPLACEMENT PARTS	23
<i>Fig. 35 Capacities and Replacement Parts</i>	23
GENERAL SPECIFICATIONS	25
SHUTTLE 2 GASOLINE POWERED CARGO CARRIER	26
SHUTTLE 4 GASOLINE POWERED PERSONNEL / CARGO CARRIER	27
SHUTTLE 6 GASOLINE POWERED PERSONNEL CARRIER	28
TG5 GASOLINE POWERED 5 PASSENGER GOLF CAR	29
<i>Fig. 36 Vehicle Dimensions</i>	30
<i>Fig. 37 Vehicle Dimensions</i>	31
<i>Fig. 38 Vehicle Dimensions and Incline Specifications</i>	32
VEHICLE WARRANTIES	35
DOMESTIC WARRANTY	36
INTERNATIONAL WARRANTY	37
FEDERAL EMISSION COMPONENT DEFECT WARRANTY	39
CALIFORNIA EMISSION CONTROL WARRANTY STATEMENT	41
DECLARATION OF CONFORMITY	45
LABELS AND PICTOGRAMS	Appendix A

SAFETY INFORMATION

This manual has been designed to assist in maintaining the vehicle in accordance with procedures developed by the manufacturer. Adherence to these procedures and troubleshooting tips will ensure the best possible service from the product. To reduce the chance of personal injury or property damage, the following must be carefully observed:

CAUTION

Certain replacement parts can be used independently and/or in combination with other accessories to modify an E-Z-GO-manufactured vehicle to permit the vehicle to operate at or in excess of 20mph. When an E-Z-GO-manufactured vehicle is modified in any way by the Distributor, Dealer or customer to operate at or in excess of 20mph, UNDER FEDERAL LAW the modified product will be a Low Speed Vehicle (LSV) subject to the strictures and requirements of Federal Motor Vehicle Safety Standard 571.500. In these instances, pursuant to Federal law the Distributor or Dealer MUST equip the product with headlights, rear lights, turn signals, seat belts, top, horn and all other modifications for LSV's mandated in FMVSS 571.500, and affix a Vehicle Identification Number to the product in accordance with the requirements of FMVSS 571.565. Pursuant to FMVSS 571.500, and in accordance with the State laws applicable in the places of sale and use of the product, the Distributor, Dealer or customer modifying the vehicle also will be the Final Vehicle Manufacturer for the LSV, and required to title or register the vehicle as mandated by State law.

E-Z-GO will NOT approve Distributor, Dealer or customer modifications converting E-Z-GO products into LSV's.

The Company, in addition, recommends that all E-Z-GO products sold as personal transportation vehicles BE OPERATED ONLY BY PERSONS WITH VALID DRIVERS LICENSES, AND IN ACCORDANCE WITH APPLICABLE STATE REQUIREMENTS. This restriction is important to the SAFE USE AND OPERATION of the product. On behalf of E-Z-GO, I am directing that E-Z-GO Branch personnel, Distributors and Dealers advise all customers to adhere to this SAFETY RESTRICTION, in connection with the use of all products, new and used, the Distributor or Dealer has reason to believe may be operated in personal transportation applications.

Information on FMVSS 571.500 can be obtained at Title 49 of the Code of Federal Regulations, section 571.500, or through the Internet at the website for the U.S. Department of Transportation - at Dockets and Regulation, then to Title 49 of the Code of Federal Regulations (Transportation).

GENERAL

Many vehicles are used for a variety of tasks beyond the original intended use of the vehicle; therefore, it is impossible to anticipate and warn against every possible combination of circumstances that may occur. No warnings can take the place of good common sense and prudent driving practices.

Good common sense and prudent driving practices do more to prevent accidents and injury than all of the warnings and instructions combined. The manufacturer strongly suggests that all users and maintenance personnel read this entire manual paying particular attention to the CAUTIONS and WARNINGS contained therein.

If you have any questions regarding this vehicle, contact your closest representative or write to the address on the back cover of this publication, Attention: Product Service Department.

The manufacturer reserves the right to make design changes without obligation to make these changes on units previously sold and the information contained in this manual is subject to change without notice.

The manufacturer is not liable for errors in this manual or for incidental or consequential damages that result from the use of the material in this manual.

This vehicle conforms to the current applicable standard(s) for safety and performance requirements.

These vehicles are designed and manufactured for off-road use. They do not conform to Federal Motor Vehicle Safety

SAFETY INFORMATION

Standards of the United States of America (USA) and are not equipped for operation on public streets. Some communities may permit these vehicles to be operated on their streets on a limited basis and in accordance with local ordinances.

Refer to GENERAL SPECIFICATIONS for vehicle seating capacity.

Never modify the vehicle in any way that will alter the weight distribution of the vehicle, decrease its stability or increase the speed beyond the factory specification. Such modifications can cause serious personal injury or death. Modifications that increase the speed and/or weight of the vehicle will extend the stopping distance and may reduce the stability of the vehicle. Do not make any such modifications or changes. The manufacturer prohibits and disclaims responsibility for any such modifications or any other alteration which would adversely affect the safety of the vehicle.

Vehicles that are capable of higher speeds must limit their speed to no more than the speed of other vehicles when used in a golf course environment. Additionally, speed should be further moderated by the environmental conditions, terrain and common sense.

GENERAL OPERATION

Always:

- Use the vehicle in a responsible manner and maintain the vehicle in safe operating condition.
- Read and observe all warnings and operation instruction labels affixed to the vehicle.
- Follow all safety rules established in the area where the vehicle is being operated.
- Reduce speed to compensate for poor terrain or conditions.
- Apply service brake to control speed on steep grades.
- Maintain adequate distance between vehicles.
- Reduce speed in wet areas.
- Use extreme caution when approaching sharp or blind turns.
- Use extreme caution when driving over loose terrain.
- Use extreme caution in areas where pedestrians are present.

MAINTENANCE

Always:

- Maintain the vehicle in accordance with the manufacturer's periodic service schedule.
- Ensure that repairs are performed by those that are trained and qualified to do so.
- Follow the manufacturer's maintenance procedures for the vehicle. Be sure to disable the vehicle before performing any maintenance. Disabling includes removing the key from the key switch and removal of a battery wire.
- Insulate any tools used within the battery area in order to prevent sparks or battery explosion caused by shorting the battery terminals or associated wiring. Remove the battery or cover exposed terminals with an insulating material.
- Use specified replacement parts. Never use replacement parts of lesser quality.

SAFETY INFORMATION

- Use recommended tools.
- Determine that tools and procedures not specifically recommended by the manufacturer will not compromise the safety of personnel nor jeopardize the safe operation of the vehicle.
- Support the vehicle using wheel chocks and jack stands. Never get under a vehicle that is supported by a jack. Lift the vehicle in accordance with the manufacturer's instructions.
- Empty the fuel tank or plug fuel hoses to prevent fuel leakage.
- Maintain the vehicle in an area away from exposed flame or persons who are smoking.
- Be aware that a vehicle that is not performing as designed is a potential hazard and must not be operated.
- Test drive the vehicle after any repairs or maintenance. All tests must be conducted in a safe area that is free of both vehicular and pedestrian traffic.
- Replace damaged or missing warning, caution or information labels.
- Keep complete records of the maintenance history of the vehicle.

The manufacturer cannot anticipate all situations, therefore people attempting to maintain or repair the vehicle must have the skill and experience to recognize and protect themselves from potential situations that could result in severe personal injury or death and damage to the vehicle. Use extreme caution and, if unsure as to the potential for injury, refer the repair or maintenance to a qualified mechanic.

VENTILATION

Always store gasoline vehicles in a well ventilated area. Ventilation prevents gasoline fumes from accumulating.

Never fuel a vehicle in an area that is subject to flame or spark. Pay particular attention to natural gas or propane water heaters and furnaces.

Never work around or operate a vehicle in an environment that does not ventilate exhaust gases from the area. Carbon monoxide is a dangerous gas that can cause unconsciousness and is potentially lethal.

SAFETY INFORMATION

Read all of manual to become thoroughly familiar with this vehicle. Pay particular attention to all Notes, Cautions and Warnings

GENERAL

The following text is provided as recommended by part II of ASME/ANSI B56.8-1988. The Manufacturer strongly endorses the contents of this specification.

PART II FOR THE USER

4 GENERAL SAFETY PRACTICES

4.1 Introduction

4.1.1 Like other machines, carriers can cause injury if improperly used or maintained. Part II contains broad safety practices applicable to carrier operations. Before operation, the user shall establish such additional specific safety practices as may reasonably be required for safe operation.

4.2 Stability

4.2.1 Experience has shown that this vehicle, which complies with this standard, is stable when properly operated and when operated in accordance with specific safety rules and practices established to meet actual operating terrain and conditions. However, improper operation, faulty maintenance, or poor housekeeping may contribute to a condition of instability and defeat the purpose of the standard. Some of the conditions which may affect stability are failure of the user to follow safety practices; also, ground and floor conditions, grade, speed, loading, the operation of the carrier with improper loads, battery weight, dynamic and static forces, and the judgement exercised by the carrier operator.

(a) The user shall train carrier operators to adhere strictly to the operating instructions stated in this Standard.

(b) The user shall survey specific operating conditions and environment, and establish and train carrier operators to comply with additional, specific safety practices.

4.3 Nameplates, Markings, Capacity, and Modifications

4.3.1 The user shall maintain in a legible condition all nameplates, warnings, and instructions which are supplied by the manufacturer.

4.3.2 The user shall not perform any modification or addition which affects capacity or safe operation, or make any change not in accordance with the owner's

manual without the manufacturer's prior written authorization. Where authorized modifications have been made, the user shall ensure that capacity, operation, warning, and maintenance instruction plates, tags, or decals are changed accordingly.

4.3.3 As required under paras. 4.3.1 or 4.3.2, the manufacturer shall be contacted to secure new nameplates, warnings, or instructions which shall then be affixed in their proper place on the carrier.

4.4 Fuel Handling and Storage

4.4.1 The user shall supervise the storage and handling of liquid fuels (when used) to be certain that it is in accordance with appropriate paragraphs of ANSI/NFPA 505 and ANSI/NFPA 30.

4.4.2 Storage and handling of liquefied petroleum gas fuels shall be in accordance with appropriate paragraphs of ANSI/NFPA 505 and ANSI/NFPA 58. If such storage or handling is not in compliance with these standards, the user shall prevent the carrier from being used until such storage and handling is in compliance with these standards.

4.5 Changing and Charging Storage Batteries for Electric Personnel and Burden Carriers

4.5.1 The user shall require battery changing and charging facilities and procedures to be in accordance with appropriate paragraphs of ANSI/NFPA 505.

4.5.2 The user shall periodically inspect facilities and review procedures to be certain that appropriate paragraphs of ANSI/NFPA 505, are strictly complied with, and shall familiarize carrier operators with it.

4.6 Hazardous Locations

4.6.1 The user shall determine the hazard classification of the particular atmosphere or location in which the carrier is to be used in accordance with ANSI/NFPA 505.

4.6.2 The user shall permit in hazardous areas only those carriers approved and of the type required by ANSI/NFPA 505.

4.7 Lighting for Operating Areas

4.7.1 The user, in accordance with his responsibility to survey the environment and operating conditions, shall determine if the carrier requires lights and, if so, shall equip the carrier with appropriate lights in accordance with the manufacturer's recommendations.

SAFETY INFORMATION

Read all of manual to become thoroughly familiar with this vehicle. Pay particular attention to all Notes, Cautions and Warnings

4.8 Control of Noxious Gases and Fumes

4.8.1 When equipment powered by internal combustion engines is used in enclosed areas, the atmosphere shall be maintained within limits specified in the American Conference of Governmental Industrial Hygienists publication, "Threshold Limit Values for Chemical Substances and Physical Agents in the Workroom Environment". This shall be accomplished by ventilation provided by the user, and/or the installation, use, and proper maintenance of emission control equipment recommended or provided by the manufacturer of the equipment.

4.9 Warning Device(s)

4.9.1 The user shall make periodic inspections of the carrier to be certain that the sound-producing and/or visual device(s) are maintained in good operating condition.

4.9.2 The user shall determine if operating conditions require the carrier to be equipped with additional sound-producing and/or visual devices and be responsible for providing and maintaining such devices, in accordance with the manufacturer's recommendations.

5 OPERATING SAFETY RULES AND PRACTICES

5.1 Personnel and Burden Carrier Operator Qualifications

5.1.1 Only persons who are trained in the proper operation of the carrier shall be authorized to operate the carrier. Operators shall be qualified as to visual, auditory, physical, and mental ability to safely operate the equipment according to Section 5 and all other applicable parts of this Standard.

5.2 Personnel and Burden Carrier Operators' Training

5.2.1 The user shall conduct an operators' training program.

5.2.2 Successful completion of the operators' training program shall be required by the user before operation of the carrier. The program shall be presented in its entirety to all new operators and not condensed for those claiming previous experience.

5.2.3 The user should include in the operators' training program the following:

- (a) instructional material provided by the manufac-

turer;

- (b) emphasis on safety of passengers, material loads, carrier operator, and other employees;

- (c) general safety rules contained within this Standard and the additional specific rules determined by the user in accordance with this Standard, and why they were formulated;

- (d) introduction of equipment, control locations and functions, and explanation of how they work when used properly and when used improperly, and surface conditions, grade, and other conditions of the environment in which the carrier is to be operated;

- (e) operational performance tests and evaluations during, and at completion of, the program.

5.3 Personnel and Burden Carrier Operator Responsibility

5.3.1 Operators shall abide by the following safety rules and practices in paras. 5.4, 5.5, 5.6, and 5.7.

5.4 General

5.4.1 Safeguard the pedestrians at all times. Do not drive carrier in a manner that would endanger anyone.

5.4.2 Riding on the carrier by persons other than the operator is authorized only on personnel seat(s) provided by the manufacturer. All parts of the body shall remain within the plan view outline of the carrier.

5.4.3 When a carrier is to be left unattended, stop carrier, apply the parking brake, stop the engine or turn off power, turn off the control or ignition circuit, and remove the key if provided. Block the wheels if machine is on an incline.

5.4.4 A carrier is considered unattended when the operator is 25 ft. (7.6 m) or more from the carrier which remains in his view, or whenever the operator leaves the carrier and it is not within his view. When the operator is dismounted and within 25 ft. (7.6 m) of the carrier still in his view, he still must have controls neutralized, and the parking brake(s) set to prevent movement.

5.4.5 Maintain a safe distance from the edge of ramps and platforms.

5.4.6 Use only approved carriers in hazardous locations, as defined in the appropriate safety standards.

5.4.7 Report all accidents involving personnel, building structures, and equipment.

5.4.8 Operators shall not add to, or modify, the carrier.

SAFETY INFORMATION

Read all of manual to become thoroughly familiar with this vehicle. Pay particular attention to all Notes, Cautions and Warnings

5.4.9 Carriers shall not be parked or left unattended such that they block or obstruct fire aisles, access to stairways, or fire equipment.

5.5 Traveling

5.5.1 Observe all traffic regulations, including authorized speed limits. Under normal traffic conditions keep to the right. Maintain a safe distance, based on speed of travel, from a carrier or vehicle ahead; and keep the carrier under control at all times.

5.5.2 Yield the right of way to pedestrians, ambulances, fire trucks, or other carriers or vehicles in emergency situations.

5.5.3 Do not pass another carrier or vehicle traveling in the same direction at intersections, blind spots, or at other dangerous locations.

5.5.4 Keep a clear view of the path of travel, observe other traffic and personnel, and maintain a safe clearance.

5.5.5 Slow down or stop, as conditions dictate, and activate the sound-producing warning device at cross aisles and when visibility is obstructed at other locations.

5.5.6 Ascend or descend grades slowly.

5.5.7 Avoid turning, if possible, and use extreme caution on grades, ramps, or inclines; normally travel straight up and down.

5.5.8 Under all travel conditions the carrier shall be operated at a speed that will permit it to be brought to a stop in a safe manner.

5.5.9 Make starts, stops, turns, or direction reversals in a smooth manner so as not to shift the load, endanger passengers, or overturn the carrier.

5.5.10 Do not indulge in dangerous activities, such as stunt driving or horseplay.

5.5.11 Slow down when approaching, or on, wet or slippery surfaces.

5.5.12 Do not drive carrier onto any elevator unless specifically authorized to do so. Approach elevators slowly, and then enter squarely after the elevator car is properly leveled. Once on the elevator, neutralize the controls, shut off power, and set parking brakes. It is advisable that all other personnel leave the elevator before a carrier is allowed to enter or exit.

5.5.13 Avoid running over loose objects, potholes, and bumps.

5.5.14 To negotiate turns, reduce speed to improve stability, then turn hand steering wheel or tiller in a

smooth, sweeping motion.

5.6 Loading

5.6.1 Handle only stable and safely arranged loads. When handling off-center loads which cannot be centered, operate with extra caution.

5.6.2 Handle only loads within the capacity of the carrier as specified on the nameplate.

5.6.3 Handle loads exceeding the dimensions used to establish carrier capacity with extra caution. Stability and maneuverability may be adversely affected.

5.7 Operator Care of Personnel and Burden Carriers

5.7.1 At the beginning of each shift during which the carrier will be used, the operator shall check the carrier condition and inspect the tires, warning devices, lights, battery(s), speed and directional controllers, brakes, and steering mechanism. If the carrier is found to be in need of repair, or in any way unsafe, the matter shall be reported immediately to the designated authority and the carrier shall not be operated until it has been restored to safe operating condition.

5.7.2 If during operation the carrier becomes unsafe in any way, the matter shall be reported immediately to the designated authority, and the carrier shall not be operated until it has been restored to safe operating condition.

5.7.3 Do not make repairs or adjustments unless specifically authorized to do so.

5.7.4 The engine shall be stopped and the operator shall leave the carrier while refueling.

5.7.5 Spillage of oil or fuel shall be carefully and completely absorbed or evaporated and fuel tank cap replaced before starting engine.

5.7.6 Do not operate a carrier with a leak in the fuel system or battery(s).

5.7.7 Do not use open flames for checking electrolyte level in storage battery(s) or liquid level in fuel tanks.

6 MAINTENANCE PRACTICES

6.1 Introduction

6.1.1 Carriers may become hazardous if maintenance is neglected. Therefore, maintenance facilities, trained personnel, and procedures shall be provided. Such facilities may be on or off the premises.

SAFETY INFORMATION

Read all of manual to become thoroughly familiar with this vehicle. Pay particular attention to all Notes, Cautions and Warnings

6.2 Maintenance Procedures

6.2.1 Maintenance and inspection of all carriers shall be performed in conformance with the manufacturer's recommendations and the following practices.

(a) A scheduled preventive maintenance, lubrication, and inspection system shall be followed.

(b) Only qualified and authorized personnel shall be permitted to maintain, repair, adjust, and inspect carriers.

(c) Before undertaking maintenance or repair, follow the manufacturer's recommendations for immobilizing the carrier.

(d) Block chassis before working underneath it.

(e) Before disconnecting any part of the engine fuel system of a gasoline or diesel powered carrier with gravity feed fuel systems, be sure shutoff valve is closed, and run engine until fuel system is depleted and engine stops running.

(f) Before disconnecting any part of the engine fuel system of LP gas powered carriers, close the LP gas cylinder valve and run the engine until fuel in the system is depleted and the engine stops running.

(g) Operation to check performance of the carrier shall be conducted in an authorized area where safe clearance exists.

(h) Before commencing operation of the carrier, follow the manufacturer's instructions and recommended procedures.

(i) Avoid fire hazards and have fire protection equipment present in the work area. Do not use an open flame to check level or leakage of fuel, battery electrolyte, or coolant. Do not use open pans of fuel or flammable cleaning fluids for cleaning parts.

(j) Properly ventilate the work area.

(k) Handle LP gas cylinders with care. Physical damage, such as dents, scrapes, or gouges, may dangerously weaken the tank and make it unsafe for use.

(l) Brakes, steering mechanisms, speed and directional control mechanisms, warning devices, lights, governors, guards, and safety devices shall be inspected regularly and maintained in a safe operating condition.

(m) Special carriers or devices designed and approved for hazardous area operation shall be inspected to ensure that maintenance preserves the original approved safe operating features.

(n) Fuel systems shall be checked for leaks and condition of parts. If a leak is found, action shall be taken to

prevent the use of the carrier until the leak has been eliminated.

(o) The carrier manufacturer's capacity, operation, and maintenance instruction plates, tags, or decals shall be maintained in legible condition.

(p) Batteries, motors, speed and directional controllers, limit switches, protective devices, electrical conductors, and connections shall be inspected and maintained in conformance with manufacturers recommended procedures.

(q) Carriers shall be kept in a clean condition to minimize fire hazards and facilitate detection of loose or defective parts.

(r) Modifications and additions which affect capacity and safe machine operation shall not be performed by the customer or user without manufacturer's prior written authorization; where authorized modifications have been made, the user shall ensure that capacity, operation, warning, and maintenance instruction plates, tags, or decals are changed accordingly.

(s) Care shall be taken to ensure that all replacement parts are interchangeable with the original parts and of a quality at least equal to that provided in the original equipment.

END OF ASME/ANSI B56.8 - 1988 TEXT

SAFETY INFORMATION

Read all of manual to become thoroughly familiar with this vehicle. Pay particular attention to all Notes, Cautions and Warnings

GENERAL

The following text is provided as recommended by part II of ANSI / GCMA Z130.1 - 1993. E-Z-GO, as a member of the National Golf Car Manufacturers Association (NGCMA), strongly endorses the contents of this specification.

PART II

MAINTENANCE AND OPERATIONS

5. GENERAL SAFETY PRACTICES

5.1. Introduction

Like other machines, golf cars can cause injury if improperly used or maintained. This section contains broad safety practices recommended for safe golf car operations. Before operation, the controlling party should establish such additional specific safety practices as may be reasonably required for safe operations.

Experience has shown that golf cars which comply with the provisions stated in Part II of this Standard are safe when properly operated in accordance with the safety and operation warnings affixed to every golf car. The safe operation is enhanced when the golf cars are operated within a specific set of operation instructions, safety rules and practices established to meet actual operating terrain and conditions.

The safety information contained in Part II is intended to provide the controlling party with basic safety information and to encourage the controlling party to implement a golf car safety program.

It is suggested and recommended that Part II be reprinted in the golf car manufacturer's operation and service manuals to encourage safe operations and practices at the controlling party's facility.

5.2. Safety Survey

The controlling party shall perform a safety survey periodically, and as conditions warrant to their premises, to identify areas where golf cars should not be operated and to identify possible hazards.

5.2.1. Steep Grade

In areas where steep grades exist, golf car operations should be restricted to the designated golf car pathways where possible, and shall be identified with a suitable warning giving the following information: "Warning, steep grade, descend slowly with one foot on brake."

5.2.2. Wet Areas

Wet grassy areas may cause a golf car to lose traction and may affect stability. Wet areas shall be chained or roped off to prevent golf car operations or be identified by a suitable warning not to operate golf cars in this area due to wet terrain.

5.2.3. Sharp Turns, Blind Corners, Bridge Approaches

Sharp turns, blind spots, bridge approaches and other potentially hazardous areas shall be either chained or roped off to prevent golf car operations or identified with a suitable warning to the operator of the nature of the hazard and stating the proper precautions to be taken to avoid the hazard.

5.2.4. Loose Terrain

Loose terrain may cause a golf car to lose traction and may affect stability. Areas of loose terrain should be repaired if possible, or chained or roped off to prevent golf car operation or identified by a suitable warning to operators not to operate golf cars in this area due to loose terrain or possible hazardous conditions.

5.2.5. Golf Car/Pedestrian Interference Areas

Areas where pedestrians and golf cars interfere shall be avoided whenever possible by rerouting the golf car traffic or the pedestrian traffic to eliminate the interference. If elimination of the interference is not possible or is highly impractical, signs shall be erected warning pedestrians of the golf car traffic and golf car operators of the pedestrian traffic and to drive slowly and use extreme caution.

SAFETY INFORMATION

Read all of manual to become thoroughly familiar with this vehicle. Pay particular attention to all Notes, Cautions and Warnings

6. MAINTENANCE

6.1. Introduction

6.1.1. Golf cars may become hazardous if maintenance is neglected or improperly performed. Therefore maintenance facilities, trained personnel and procedures in accordance with the manufacturer's recommendations should be provided by the controlling party.

6.2. Preventive Maintenance

A regularly scheduled inspection and preventive maintenance program in accordance with the manufacturer's recommendations should be established. Such a program will be a valuable tool in providing the golfing patron with a safe, properly operating golf car and thereby help to avoid accidents.

6.2.1. Personnel

Only qualified, trained and authorized personnel shall be permitted to inspect, adjust and maintain golf cars.

6.2.2. Parts and Materials

Only manufacturer's recommended replacement parts and materials shall be used.

6.2.3. Ventilation

Maintenance and storage areas shall be properly ventilated to avoid fire hazards in accordance with applicable fire codes and ordinances.

6.2.3.1. Ventilation for gasoline powered golf cars shall be provided to remove flammable vapors, fumes and other flammable materials. Consult applicable fire codes for specific levels of ventilation.

6.2.3.2. Ventilation for electric powered golf cars shall be provided to remove the accumulation of flammable hydrogen gas emitted during the charging process. The amount of hydrogen gas emitted depends upon a number of factors such as the condition of the batteries, the output rate of the battery charger and the amount of time the batteries are on charge. Hydrogen emissions are generally considered to be in the area of 10 to 20 cubic

liters per car per charge. Because of the highly volatile nature of hydrogen gas and its propensity to rise and accumulate at the ceiling in pockets, a minimum of 5 air changes per hour is recommended. The controlling party shall consult applicable fire and safety codes for the specific ventilation levels required as well as the use of explosion proof electrical apparatus.

6.2.4. Maintenance Procedures

All maintenance shall be performed in accordance with the manufacturer's recommended maintenance procedures as outlined in the manufacturer's operation and service manuals.

6.2.5. Maintenance Safety Procedures

All maintenance shall be performed in accordance with the manufacturer's recommended safety procedures as outlined in the manufacturer's operation and service manuals. The following list of recommended safety procedures are general in nature and in no way supersede the manufacturer's specific instructions.

6.2.5.1. Follow manufacturer's instructions for immobilizing golf car before beginning any maintenance.

6.2.5.2. Block chassis before working underneath golf car.

6.2.5.3. Before disconnecting any part of the fuel system, drain the system and turn all shut off valves to the 'OFF' position to prevent leakage or accumulation of flammable fuels in the work area.

6.2.5.4. Avoid fire hazards and have fire protection equipment available.

6.2.5.5. Before performing any maintenance on an electric golf car, disable the electrical system in accordance with the manufacturer's instructions.

6.2.5.6. Use only properly insulated tools when working on electrically powered golf cars or around batteries.

6.2.5.7. Brakes, steering mechanisms, warning devices,

SAFETY INFORMATION

Read all of manual to become thoroughly familiar with this vehicle. Pay particular attention to all Notes, Cautions and Warnings

governors and all other safety devices shall be inspected and maintained in a safe and proper operating condition and shall not be modified as supplied by the manufacturer.

6.2.5.8. After each maintenance or repair the golf car shall be driven by qualified, trained and authorized personnel to ensure proper operation and adjustment.

6.2.5.9. Driving golf car to check for proper operation and adjustment after repair shall be performed in an area that is free of vehicular and pedestrian traffic.

6.2.5.10. Record all maintenance performed in a maintenance record log by date, name of person performing maintenance and type of maintenance. Controlling party management should periodically inspect maintenance log to ensure currency and completeness of entries.

6.2.5.11. Provide operator comment cards to assist in identifying non-periodic maintenance needs for specific golf cars.

6.2.6. The controlling party shall maintain in a legible condition all nameplates, warnings and instructions which are supplied by the manufacturer.

6.2.7. The controlling party shall not perform any modification or addition which affects capacity or safe operation, or make any change not in accordance with the owner's manual without the manufacturer's prior written authorization. Where authorized modifications have been made, the controlling party shall ensure that capacity, operation, warning and maintenance instruction plates, tags or decals are changed accordingly.

6.2.8. As required under paragraphs 6.2.6 and 6.2.7 the manufacturer shall be contacted to secure new nameplates, warnings or instructions which shall then be affixed in their proper place on the golf car.

7. FUELS HANDLING AND STORAGE/ BATTERY CHARGING

7.1. The controlling party shall supervise the storage and handling of liquid fuels in accordance with applicable fire and safety requirements.

7.2. Storage and handling of liquefied petroleum gas fuels shall be in accordance with American Gas Association recommendations and applicable fire safety requirements.

7.3. The controlling party shall require battery charging and charging facilities and procedures to be in accordance with applicable ordinances or regulations (also see paragraph 6.2.3.2).

7.4. The controlling party shall periodically inspect facilities and review procedures to be certain that the procedures in paragraphs 6.2.3.2 and 7.3 are being followed.

8. OPERATING SAFETY RULES AND PRACTICES

8.1. Operator Qualifications

8.1.1. Only authorized persons shall be allowed to operate golf cars. It is recommended that no persons be allowed to operate golf cars except those persons who possess a valid motor vehicle driver's license.

8.1.2. The controlling party shall display the operation and safety instructions as recommended by the golf car manufacturers and the golf course safety rules in a conspicuous place near the golf car rental area or golf car pick-up area. It is also recommended, as with all motor vehicles, that the warning "Do not operate golf cars when under the influence of alcohol or drugs." be posted in a conspicuous location.

OPERATION AND SERVICE INFORMATION

Read all of manual to become thoroughly familiar with this vehicle. Pay particular attention to all Notes, Cautions and Warnings

Thank you for purchasing this vehicle. Before driving the vehicle, we ask you to spend some time reading this Owner's Manual and Service Guide. This guide contains the information that will assist you in maintaining this highly reliable vehicle. Some illustrations may show items that are optional for your vehicle. This guide covers the operation of several vehicles; therefore, some pictorial views may not represent your vehicle. Physical differences in controls will be illustrated.

This vehicle has been designed and manufactured as a 'World Vehicle'. Some countries have individual requirements to comply with their specifications; therefore, some sections may not apply in your country.

Most of the service procedures in this guide can be accomplished using common automotive hand tools. Contact your service representative on servicing the vehicle in accordance with the Periodic Service Schedule.

Service Parts Manuals and Technician's Repair and Service Manuals are available from a local Distributor, an authorized Branch or the Service Parts Department. When ordering parts or requesting information for your vehicle, provide vehicle model, serial number and manufacture code.

BEFORE INITIAL USE

Read, understand and follow the safety label on the instrument panel. Be sure you understand how to operate the vehicle, its equipment and how to use it safely. Maintaining good performance depends to a large extent on the operator.

⚠ WARNING ⚠ *Hydrogen gas is generated as a natural part of the lead acid battery charging process. A 4% concentration of hydrogen gas is explosive and could cause severe injury or death. Charging must take place in an area that is adequately ventilated (minimum of 5 air exchanges per hour).*

To reduce the chance of battery explosion that could result in severe injury or death, never smoke around or charge batteries in an area that has open flame or electrical equipment that could cause an electrical arc.

Before a new vehicle is put into operation, the items shown in the INITIAL SERVICE CHART must be performed (Ref. Fig. 1 on page 1).

Vehicle battery must be fully charged before initial use.

Check for correct tire inflation. See GENERAL SPECIFICATIONS.

Check for oil or fuel leaks that could have developed in shipment from the factory.

Determine and record braking distance required to stop vehicle for future brake performance tests.

Remove the protective clear plastic, that protect the seat bottom and back rest during shipping, before placing the vehicle in service.

ARTICLE	OPERATION D'ENTRETIEN
Batteries	Charger les batteries
Sièges	Retirer les revêtements en plastique
Freins	Vérifier le fonctionnement et régler au besoin
	Vérifier le niveau d'huile hydraulique, s'il y a lieu
	Définir la distance d'arrêt admissible
Pneus	Vérifier la pression d'air (voir SPECIFICATIONS)
Carburant	Remplir le réservoir de carburant recommandé
Moteur	Vérifier le niveau d'huile

Ref Isc 6

Fig. 1 Initial Service Chart

CONTROLS AND INDICATORS

Vehicle controls and indicators consist of:

- key/light switch
- direction selector
- choke
- fuel gauge
- low oil pressure indicator light
- accelerator pedal
- combination service and park brake pedal
- horn

KEY/LIGHT SWITCH

Located on the dash panel, this switch enables the basic electrical system of the vehicle to be turned on and off by turning the key. To prevent inadvertent operation of the vehicle when left unattended, the key should be turned to the 'OFF' position and removed (Ref. Fig. 2 on page 2).

If the vehicle is equipped with lights, the key switch has a position to operate them, indicated by the light icon.

OPERATION AND SERVICE INFORMATION

Read all of manual to become thoroughly familiar with this vehicle. Pay particular attention to all Notes, Cautions and Warnings

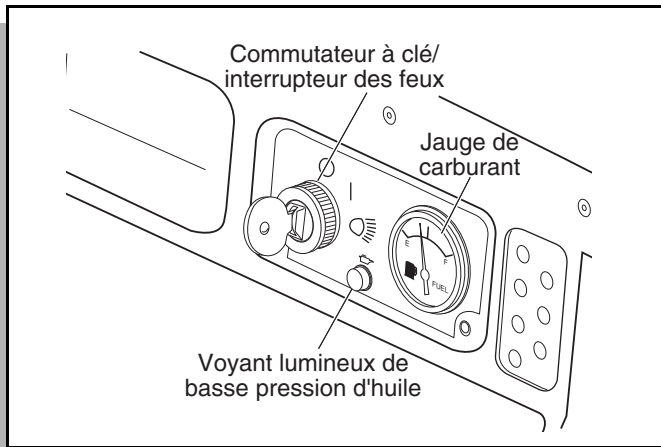

Fig. 2 Key/Light Switch, Low Oil Pressure Light and Fuel Gauge

NOTE If the vehicle is equipped with factory installed custom accessories, some accessories remain operational with the key switch in the 'OFF' position.

DIRECTION SELECTOR

CAUTION To reduce the possibility of component damage, the vehicle must be completely stopped before moving the direction selector.

Located on the seat support panel, this lever permits the selection of either 'F' (forward) or 'R' (reverse) (Ref. Fig. 3 on page 2). Vehicle should be left in 'F' when unattended.

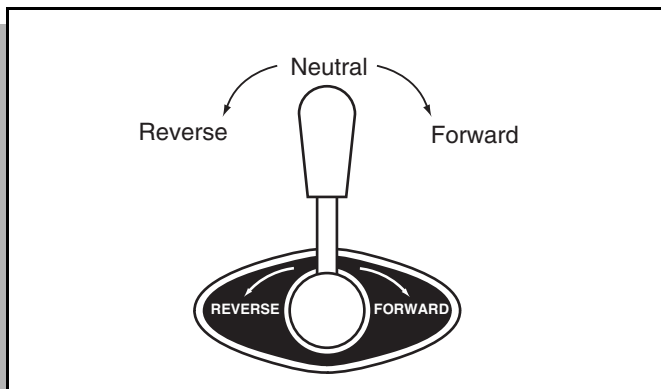

Fig. 3 Direction Selector

CHOKE

The choke is used to aid cold starting (Ref. Fig. 4 on page 2). See COLD STARTING section for operating instructions.

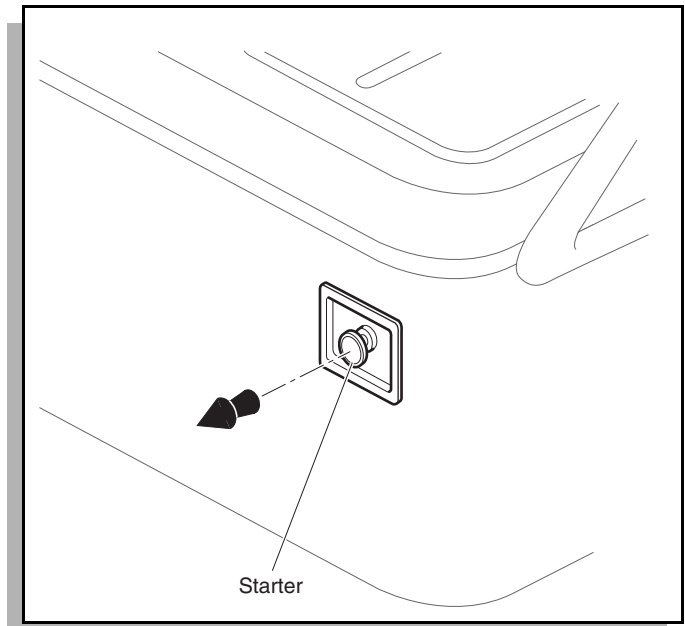

Fig. 4 Choke

FUEL GAUGE

The electric fuel gauge is located on the dash panel (Ref. Fig. 2 on page 2).

LOW OIL PRESSURE INDICATOR LIGHT

A low oil pressure indicator light is located on the dash panel (Ref. Fig. 2 on page 2). The light illuminates when the oil pressure is low. Check oil level. If oil level is between ADD and FULL mark on dipstick, a mechanical problem exists within the engine and the vehicle **must not be driven**. Contact a local distributor or authorized branch.

CAUTION To prevent engine damage, do not operate engine until oil pressure is corrected. Do not overfill engine. Too much oil may cause smoking or allow oil to enter the air filter enclosure.

If oil level is below ADD mark on dipstick, add oil to bring level to FULL mark. Drive vehicle a short distance and check oil pressure. If oil light does not come on, continue to use vehicle.

ACCELERATOR PEDAL

WARNING Unintentional movement of the accelerator pedal will release the park brake and may cause the vehicle to move which could result in severe injury or death.

OPERATION AND SERVICE INFORMATION

Read all of manual to become thoroughly familiar with this vehicle. Pay particular attention to all Notes, Cautions and Warnings

With the key switch 'ON', depressing the accelerator pedal starts the engine. When the pedal is released, the engine will stop (Ref. Fig. 5 on page 3). To stop the vehicle more quickly, depress the service brake.

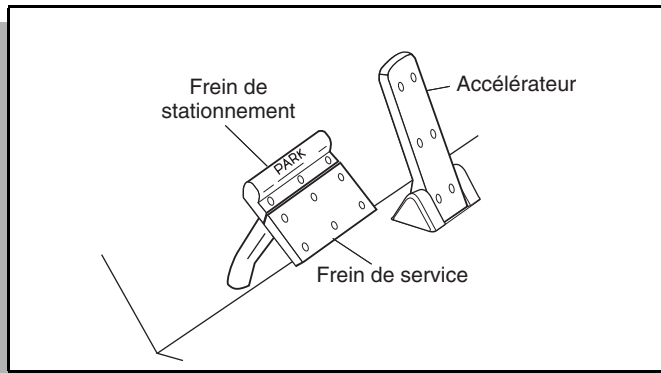

Fig. 5 Accelerator and Brake Controls

If key switch is 'ON' and park brake is set, depressing the accelerator inadvertently will release the park brake and will cause the vehicle to move which could cause severe injury or death.

Depressing the accelerator pedal will release the park brake if it is engaged. This is a feature to assure the vehicle is not driven with the park brake engaged. Depressing the accelerator pedal is **not** the preferred method of releasing the park brake.

NOTE *Depressing the lower section of the brake pedal is the preferred method of releasing the park brake to assure the longest service life of brake components.*

COMBINATION SERVICE AND PARK BRAKE PEDAL WITH FRONT DISC BRAKES (OPTIONAL)

The brake system consists of mechanically activated rear drum brakes and hydraulically operated front disc brakes. The front brakes are designed to operate under hard braking conditions.

The front disc brakes are designed to activate as the brake pedal reaches the 'park or latch position'. Depressing the brake pedal further will increase the effectiveness of the front brakes.

HORN

The horn is operated by pushing the horn button located on the floor to the left of the brake pedal (Ref. Fig. 6 on page 3).

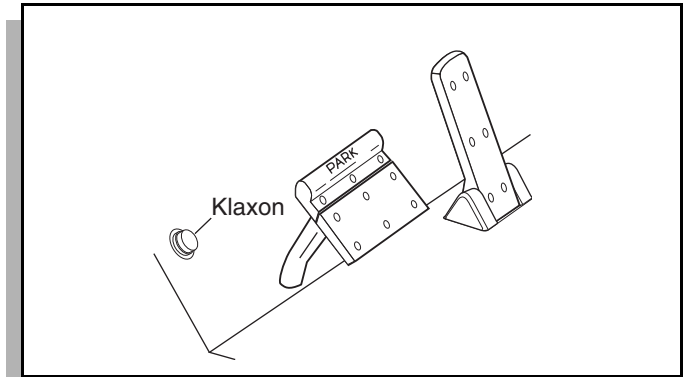

Fig. 6 Horn Button

OPERATING THE VEHICLE

CAUTION Improper use of the vehicle or the lack of proper maintenance may result in damage or decreased performance.

Read and understand the following warnings before attempting to operate the vehicle.

! WARNING ! *To reduce the possibility of severe injury or death resulting from loss of vehicle control, the following warnings must be observed:*

When driving vehicle, consider the terrain, traffic conditions and the environmental factors which effect the terrain and the ability to control the vehicle.

Use extra care and reduced speed when driving on poor surfaces, such as loose dirt, wet grass, gravel, etc.

Stay in designated areas and avoid extremely rough terrain.

Maintain a safe speed when driving down hill. Use service brake to control speed when traveling down an incline. A sudden stop or change of direction may result in loss of control.

Slow down before and during turns. All turns should be made at reduced speed.

Never drive vehicle up, down, or across an incline that exceeds 14° (25% grade).

! WARNING ! *To reduce the possibility of severe injury or death resulting from improper vehicle operation, the following warnings must be*

OPERATION AND SERVICE INFORMATION

Read all of manual to become thoroughly familiar with this vehicle. Pay particular attention to all Notes, Cautions and Warnings

observed:

Refer to **GENERAL SPECIFICATIONS** for seating capacity.

To prevent inadvertent movement when the vehicle is to be left unattended, engage the park brake, move direction selector to forward position, turn key to 'OFF' position and remove key.

Make sure that the direction selector is in correct position before attempting to start the vehicle.

Always bring the vehicle to a complete stop before shifting the direction selector.

Do not take vehicle out of 'gear' while in motion (coast).

Check the area behind the vehicle before operating in reverse.

All occupants must be seated. Keep entire body inside vehicle and hold on while vehicle is in motion.

RUN-IN

Check for oil or fuel leaks that could have developed in shipment from the factory. Avoid full throttle starts and rapid acceleration until the engine has achieved operating temperature.

All engines consume more oil than normal during the first hours of operation. As internal moving parts are run-in, oil consumption should gradually decrease until the rate of consumption stabilizes.

Check the oil level per the Periodic Service Schedule. Add oil if the level on the dipstick indicates that oil is in the add oil range (Ref. Fig. 14 on page 12).

CAUTION Do not overfill engine. Too much oil may cause smoking or allow oil to enter the air filter enclosure.

NOTE Both the oil dipstick and fill cap must be in place before operating the engine. Failure to install the dipstick and fill cap will result in oil becoming contaminated and/or being discharged into the engine compartment.

The oil should be changed in accordance with the Periodic Service Schedule while the engine is warm. See **SERVICE AND MAINTENANCE** for checking oil level and changing oil procedures.

COLD STARTING

Starting a cold engine **may** require use of the choke. Depress the accelerator approximately 1" (2.5 cm) or until the starter just begins to operate. Pull the choke out

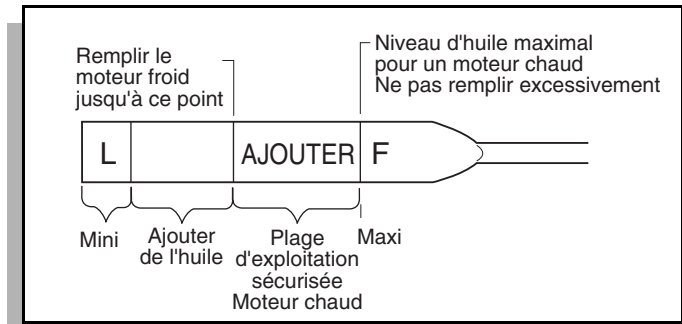

Fig. 7 Check Oil Level on Dipstick

if required. Accelerate slowly and push the choke in completely when the engine runs smoothly.

CAUTION Do not allow the starter to operate continuously for more than 10 seconds. Allow 30 seconds between starting attempts. If the vehicle does not start on the third attempt, turn the key switch off, set the park brake and determine the cause of the problem.

If the vehicle had been running and the engine does not start within 10 seconds, use the choke.

STARTING AND DRIVING

WARNING To reduce the possibility of roll-back which could result in severe injury or vehicle damage, do not release service brake until engine has started.

To operate vehicle:

- Apply the service brake, place the key in the key switch and turn it to the 'ON' position.
- Move the direction selector to the direction desired.
- Release the park brake by depressing the service brake pedal until the park brake releases.
- Slowly depress the accelerator pedal to start the engine. Release service brake when engine starts.
- When the accelerator pedal is released, the ignition circuit is de-energized and the engine stops. To stop the vehicle more quickly, depress the **service brake pedal**.

NOTE When the direction selector is in the reverse position, a warning signal will sound to indicate that the vehicle is ready to run in reverse.

OPERATION AND SERVICE INFORMATION

Read all of manual to become thoroughly familiar with this vehicle. Pay particular attention to all Notes, Cautions and Warnings

STARTING THE VEHICLE ON A HILL

⚠ WARNING ⚠ *To reduce the possibility of roll-back which could result in severe injury or vehicle damage, do not release service brake until engine has started.*

CAUTION Do not hold vehicle on hill by using accelerator and engine. This will cause premature and excessive wear to drive train components.

To reduce the possibility of permanent damage to the drive system, it is important to prevent excessive roll-back when starting the vehicle on a hill.

Place left foot on service brake and release the park brake. Depress accelerator with right foot and release the service brake by lifting left foot.

COASTING

⚠ WARNING ⚠ *To reduce the possibility of severe injury or death from coasting at above recommended speeds, limit speed with service brake.*

On steep hills, it is possible for the vehicle to coast at greater than normal speeds encountered on a flat surface. To reduce the possible loss of vehicle control and severe drivetrain damage, speeds should be limited to no more than the maximum governed speed on level ground (see GENERAL SPECIFICATIONS). Limit speed by applying service brake.

FUEL

⚠ WARNING ⚠ *To reduce the possibility of severe injury or death from improper fuel handling:*

Do not smoke near the fuel tank.

Do not refuel near open flame or electrical items which could produce a spark.

Always handle gasoline in a well ventilated area.

Always wear eye protection to protect against splashed fuel and fuel vapors.

Always allow adequate space for the expansion of gasoline. Leave at least 1" (2.5 cm) space below bottom of filler neck.

Inspect fuel cap, tank and other components for leaks or deterioration that could cause a hazard-

ous condition.

The fuel tank is located under the seat on the passenger side of the vehicle (Ref. Fig. 8 on page 5). Fill the tank with fresh, clean, automotive grade gasoline (Ref. Fig. 35 on page 23). High altitude or heavy use/load applications may benefit from higher octane gasoline.

Do not use gasoline which contains Methanol.

CAUTION Some fuels, called oxygenated or reformulated gasoline, are gasoline blended with alcohols or ethers. Excessive amounts of these blends can damage the fuel system or cause performance problems. If any undesirable operating symptoms occur, use gasoline with a lower percentage of alcohol or ether.

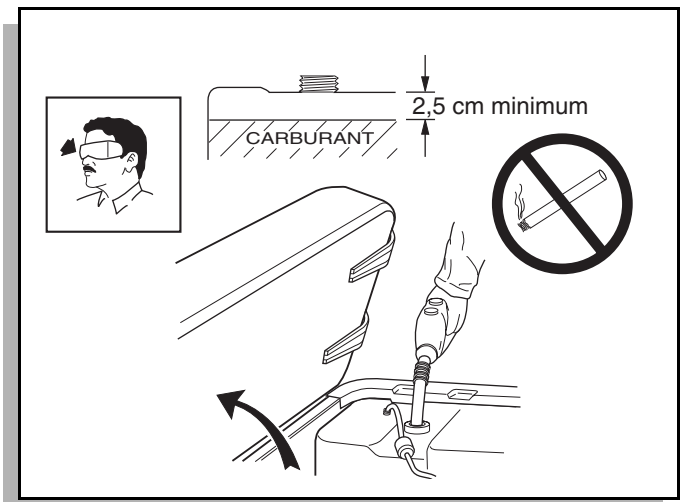

Fig. 8 Fueling

BATTERY

CAUTION Excessive use of accessories may drain the battery and leave insufficient reserve to start the vehicle.

The vehicle uses a combination starter/generator to both start the engine and charge the battery. The engine will not idle; therefore, the battery cannot be charged while the vehicle is stopped. Do not operate accessory items (such as accessory lights, radios, winch, etc.) excessively while the vehicle is stopped.

The generator is capable of supplying 35 amps; therefore, operation of all accessories could result in the discharge of the battery even though the engine is running and the generator operating. Discharging the battery is known as deep cycling. The battery is not a deep cycle model, but is a starting battery. Multiple deep cycling will result in the premature failure of the battery.

OPERATION AND SERVICE INFORMATION

Read all of manual to become thoroughly familiar with this vehicle. Pay particular attention to all Notes, Cautions and Warnings

If the vehicle battery has become discharged, it must be charged using a 12 volt charger that is rated at 10 amps or less and in accordance with all instructions provided by the manufacturer of the charger.

LABELS AND PICTOGRAMS

Vehicles may be labeled with pictograms as a method of conveying information or warnings. Appendix A illustrates and explains pictograms that may appear on the vehicle. Not all pictograms shown in Appendix A will be found on your vehicle.

SUN TOP AND WINDSHIELD



The sun top does not provide protection from roll over or falling

objects.

The windshield does not provide protection from tree limbs or flying objects.



To prevent damage to the vehicle, do not hold on to sun top struts and stand on body panels.

The sun top and windshield provide some protection from the elements; however, they will not keep the operator and passenger dry in a downpour. This vehicle is not equipped with seat belts and the sun top has not been designed to provide roll over protection. In addition, the sun top does not protect against falling objects nor does the windshield protect against flying objects and tree limbs. Keep arms and legs inside of vehicle while it is moving.

VEHICLE CLEANING AND CARE

VEHICLE CLEANING



To reduce the possibility of severe injury or vehicle damage, read and

understand all instructions supplied by manufacturer of pressure washer.



When pressure washing exterior of vehicle, do not use pressure in excess of 700 psi. To reduce the possibility of cosmetic damage, do not use any abrasive or reactive solvents to clean plastic parts.

It is important that proper techniques and cleaning materials be used. Using excessive water pressure may cause severe injury to operator or bystander, damage to

seals, plastics, seat material, body finish or electrical system. Do not use pressure in excess of 700 psi to wash exterior of vehicle.

Clean windshield with lots of water and a clean cloth. Minor scratches may be removed using a commercial plastic polish or Plexus[®] plastic cleaner available from the service parts department.

Normal cleaning of vinyl seats and plastic or rubber trim requires the use of a mild soap solution applied with a sponge or soft brush and wipe with a damp cloth.

Removal of oil, tar, asphalt, shoe polish, etc. will require the use of a commercially available vinyl/rubber cleaner.

The painted surfaces of the vehicle provide attractive appearance and durable protection. Frequent washing with lukewarm or cold water and mild detergent is required to preserve the painted surfaces.

Occasional cleaning and waxing with non-abrasive products designed for 'clear coat' automotive finishes will enhance the appearance and durability of the painted surfaces.

Corrosive materials used as fertilizers or for dust control can collect on the underbody of the vehicle. These materials will cause corrosion of underbody parts unless flushed occasionally with plain water. Thoroughly clean any areas where mud or other debris can collect. Sediment packed in closed areas should be loosened to ease it's removal, taking care not to chip or otherwise damage paint.

NOTE

If the engine does not start or runs improperly after washing, remove the spark plug wires (by pulling the spark plug boots, never the wires). Dry all connections with forced air. Reinstall the wires.

REPAIR

LIFTING THE VEHICLE

Tool List	Qty. Required
Floor jack	1
Jack stands.....	4
Chocks.....	4

Some servicing operations may require the front wheels, the rear wheels, or the entire vehicle be raised.

OPERATION AND SERVICE INFORMATION

Read all of manual to become thoroughly familiar with this vehicle. Pay particular attention to all Notes, Cautions and Warnings

⚠ WARNING ⚠ *To reduce the possibility of severe injury or death from a vehicle falling*

from a jack:

- Be sure the vehicle is on a firm and level surface.*
- Never get under a vehicle while it is supported by a jack.*
- Use jack stands and test the stability of the vehicle on the stands.*
- Always place chocks in front and behind the wheels not being raised.*
- Use extreme care since the vehicle is extremely unstable during the lifting process.*

CAUTION When lifting vehicle, position jacks and jack stands at the areas indicated only.

To raise the entire vehicle, install chocks in front and behind each front wheel (Ref. Fig. 9 on page 7). Center the jack under the rear frame crossmember. Raise the vehicle enough to place a jack stand under the outer ends of the rear axle.

Lower the jack and test the stability of the vehicle on the two jack stands.

Place the jack at the center of the front axle. Raise the vehicle enough to place jack stands under the frame crossmember as indicated.

Lower the jack and test the stability of the vehicle on all four jack stands.

If only the front or rear of the vehicle is to be raised, place the chocks in front and behind each wheel not being raised to stabilize the vehicle.

Lower the vehicle by reversing the lifting sequence.

WHEELS AND TIRES

Tire Repair

Tool List	Qty. Required
Lug wrench, 3/4"	1
Impact socket, 3/4", 1/2" drive.....	1
Impact wrench, 1/2" drive.....	1
Torque wrench, 1/2" drive	1

⚠ WARNING ⚠ *A tire explosion can cause severe injury or death. Never exceed inflation pressure rating on tire sidewall.*

To reduce the possibility of tire explosion, pres-

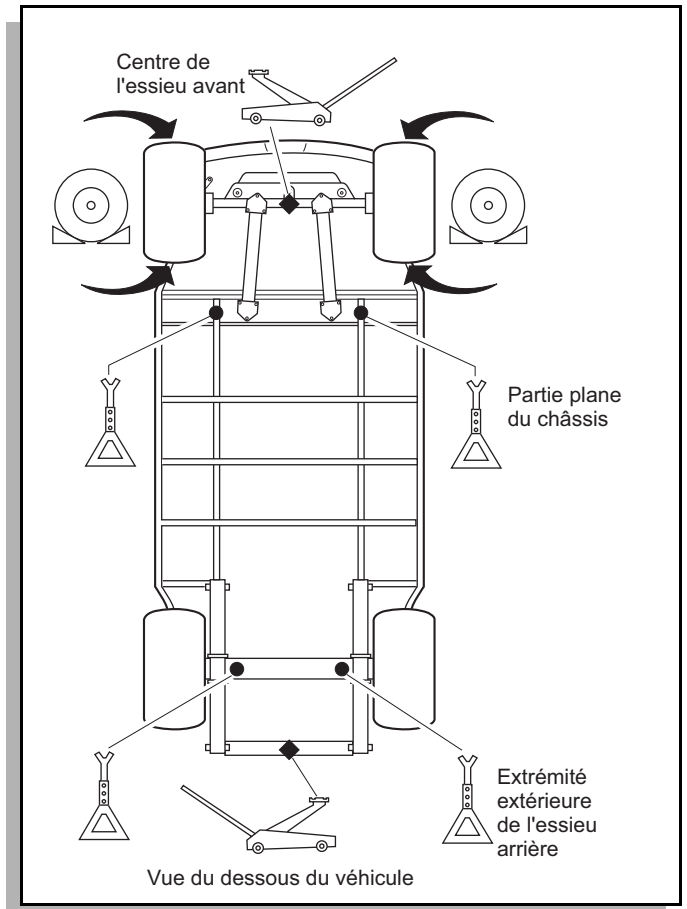

Fig. 9 Lifting the Vehicle

surize tire with small amount of air applied intermittently to seat beads. Due to the low volume of the small tires, overinflation can occur in seconds. Never exceed the tire manufacturer's recommendation when seating a bead. Protect face and eyes from escaping air when removing valve core.

To reduce the possibility of severe injury caused by a broken socket when removing wheels, use only sockets designed for impact wrench use.

Use caution when inflating tires. Overinflation could cause the tire to separate from the wheel or cause the tire to explode, either of which could cause severe injury.

Use caution when inflating tires. Due to the low volume of the small tires, overinflation can occur in seconds. Overinflation could cause the tire to separate from the wheel or cause the tire to explode.

OPERATION AND SERVICE INFORMATION

Read all of manual to become thoroughly familiar with this vehicle. Pay particular attention to all Notes, Cautions and Warnings

Tire inflation should be determined by the condition of the terrain. See GENERAL SPECIFICATIONS section for recommended tire inflation pressure. For outdoor applications with major use on grassy areas, the following should be considered. On hard turf, it is desirable to have a **slightly** higher inflation pressure. On very soft turf, a lower pressure reduces the possibility of tires cutting into the turf. For vehicles being used on paved or hard surfaces, tire inflation pressure should be in the higher allowable range, but under no condition should inflation pressure be higher than recommended on tire sidewall. **All four tires** should have the same pressure for optimum handling characteristics. Be sure to install the valve dust cap after checking or inflating.

The vehicle is fitted with low pressure tubeless tires mounted on one piece rims; therefore, the most cost effective way to repair a puncture in the tread is to use a commercial tire plug.

NOTE Tire plug tools and plugs are available at most automotive parts outlets and have the advantage of not requiring the tire be removed from the wheel.

If the tire is flat, remove the wheel and inflate the tire to the maximum recommended pressure for the tire. Immerse the tire in water to locate the leak and mark with chalk. Insert tire plug in accordance with manufacturer's instructions.

WARNING To reduce the possibility of severe injury, be sure mounting/demounting machine is anchored to floor. Wear OSHA approved safety equipment when mounting/demounting tires.

If the tire is to be removed or mounted, the tire changing machine manufacturer's recommendations must be followed in order to reduce possibility of severe injury.

Wheel Installation

CAUTION To reduce the possibility of component damage, do not tighten lug nuts to more than 85 ft. lbs. (115 Nm) torque.

NOTE It is important to follow the 'cross sequence' pattern when installing lug nuts. This will assure even seating of the wheel against the hub.

With the valve stem to the outside, mount the wheel onto the hub with lug nuts. Finger tighten lug nuts in a 'cross sequence' pattern (Ref. Fig. 10 on page 8). Tighten lug nuts to 50 - 85 ft. lbs. (70 - 115 Nm) torque in 20 ft. lbs. (30 Nm) increments following the 'cross sequence' pattern.

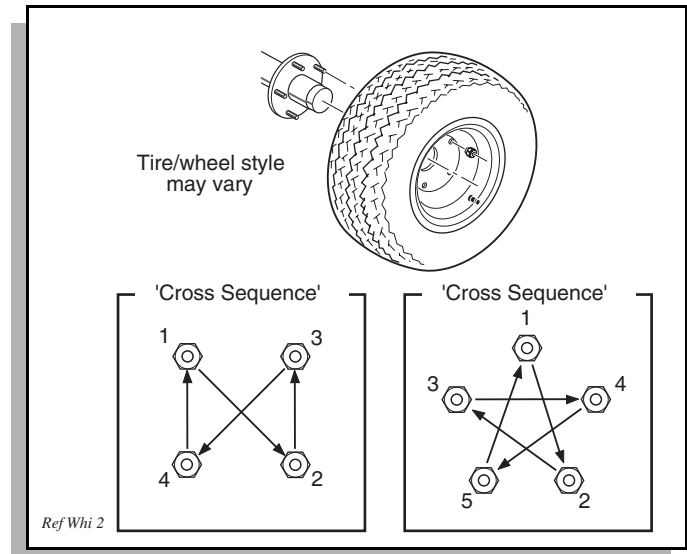

Fig. 10 Wheel Installation

LIGHT BULB REPLACEMENT

CAUTION To reduce the possibility of premature bulb failure, do not touch new bulbs with bare fingers. Use clean, dry tissue or paper towel to handle the glass portion of the bulb.

For vehicles equipped with lights mounted below cowl, locate bulb socket on backside of light bar (Ref. Fig. 11 on page 9) and turn bulb socket a quarter turn counter-clockwise to unlock and pull out bulb. Insert new bulb (Ref. CAPACITIES AND REPLACEMENT PARTS on page 23) and rotate socket a quarter turn clockwise to secure.

To replace the tail and brake light bulb, remove hardware securing lens and remove lens (Ref. Fig. 12 on page 9). Install replacement bulb (Ref. CAPACITIES AND REPLACEMENT PARTS on page 23).

To replace the tail and brake light bulb, roll the rubber bezel from around the edge of the taillight and remove lens. Install replacement bulb and replace lens.

FUSE REPLACEMENT

To replace fuses, locate the fuse block under the driver side seat. Pull out old fuse and replace with a new automotive type fuse. Headlight and taillight bulbs and fuses are available from a local Distributor, an authorized Branch or the Service Parts Department.

VEHICLE WITH A DISCHARGED BATTERY

WARNING To reduce the possibility of severe injury or death

OPERATION AND SERVICE INFORMATION

Read all of manual to become thoroughly familiar with this vehicle. Pay particular attention to all Notes, Cautions and Warnings

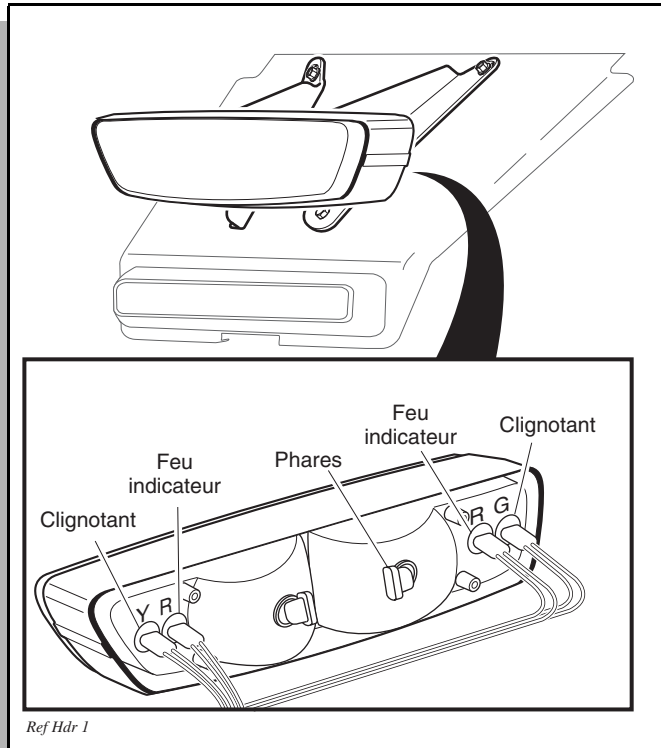

Fig. 11 Headlight, Turn Signal & Marker Light Bulb Replacement

from inadvertent motion, do not attempt to 'jump start' a vehicle.

The vehicle is equipped with a starter/generator and does not idle. When starting the engine, the starter/generator functions as a starter and with the engine running, it functions as a generator.

With the short running times associated with this kind of vehicle, the generator is more than adequate to maintain the battery charge level. The generator is not designed to charge a discharged battery.

When engine starts, the clutches engage and cause vehicle to move making 'jump starting' both dangerous and impractical.

If the vehicle battery has become discharged, it must be charged using a 12 volt charger that is rated at 10 amps or less. Read and understand all instructions provided by the manufacturer of the charger.

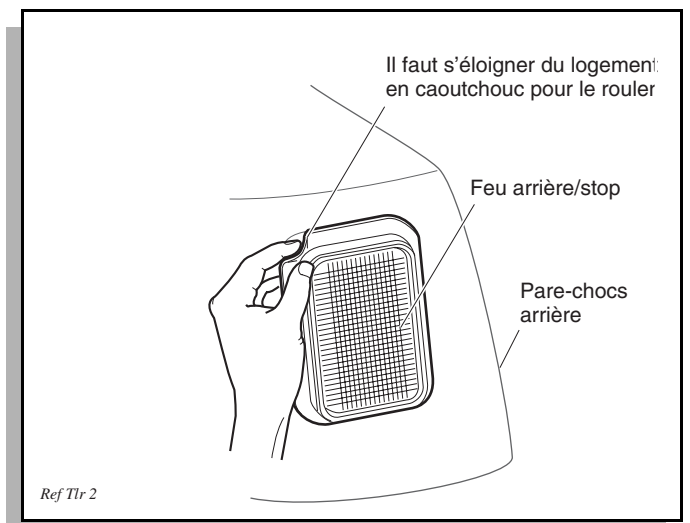

Fig. 12 Tail and Brake Light Bulb Replacement

OPERATION AND SERVICE INFORMATION

Read all of manual to become thoroughly familiar with this vehicle. Pay particular attention to all Notes, Cautions and Warnings

TRANSPORTING VEHICLE

TOWING



This vehicle is not designed to be towed.

It is recommended that the vehicle be moved by placing the entire vehicle on a trailer, flatbed truck or other suitable transport.

NEUTRAL LOCK

To prevent the driven clutch from turning the rear wheels during service operations.

To operate:

Position direction selector lever between 'F' and 'R'. Turn key switch to 'OFF'. Rotate pin on rear axle shift lever as shown (Ref. Fig. 13 on page 10). The pin will snap into a cavity in the differential case. When in this position, the direction selector remains locked in the neutral position. To unlock the direction selector, pull the pin out and rotate until the pointed portion of the pin handle fits into the detent position in the rear axle shift lever.

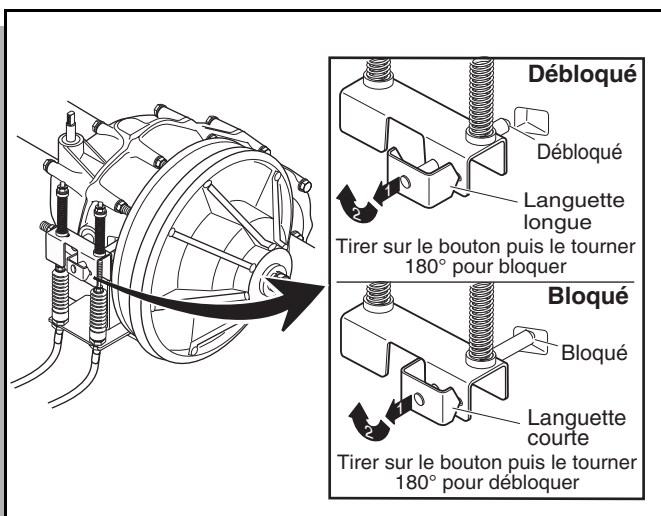

Fig. 13 Neutral Lock

HAULING



To reduce the possibility of severe injury or death while transporting vehicle:

Secure the vehicle and contents.

Never ride on vehicle being transported.

Always remove windshield before transporting.

Maximum speed with sun top installed is 50 mph (80 kph).

If the vehicle is to be transported at highway speeds, the sun top must be removed and the seat bottom secured. When transporting vehicle below highway speeds, check for tightness of hardware and cracks in sun top at mounting points. Always remove windshield when transporting. Always check that the vehicle and contents are adequately secured before transporting. The rated capacity of the trailer or truck must exceed the weight of the vehicle (see GENERAL SPECIFICATIONS for vehicle weight) and load. Lock the park brake and secure the vehicle using ratchet tie downs.

SERVICE AND MAINTENANCE



To reduce the possibility of severe injury or death from improper servicing techniques:

Do not attempt any type of servicing operations before reading and understanding all notes, cautions and warnings in this manual.

Any servicing requiring adjustments to be made to the powertrain while the engine is running must be made with both drive wheels raised and vehicle properly supported on jack stands.

To reduce the possibility of engine damage, never operate vehicle at full throttle for more than 4 - 5 seconds while vehicle is in a 'no load' condition.

Wear eye protection when working on the vehicle. Use extra care when working around batteries, or using solvents or compressed air.

To reduce the possibility of causing an electrical arc, which could result in a battery explosion, turn off all electrical loads from the battery before removing battery wires.

Wrap wrenches with vinyl tape to reduce the possibility of a dropped wrench 'shorting out' a battery, which could result in an explosion.



OPERATION AND SERVICE INFORMATION

Read all of manual to become thoroughly familiar with this vehicle. Pay particular attention to all Notes, Cautions and Warnings

Reduce the possibility of accidental starting by removing and grounding spark plug wires and disconnecting battery at negative terminal before servicing.

The electrolyte in a battery is an acid solution which can cause severe burns to the skin and eyes. Treat all electrolyte spills to the body and eyes with extended flushing with clear water. Contact a physician immediately.

Any electrolyte spills should be neutralized with a solution of 2 teaspoons (10 ml) sodium bicarbonate (baking soda) dissolved in 1 quart (1 liters) of water and flushed with water.

Aerosol containers of battery terminal protectant must be used with extreme care. Insulate metal container to reduce the possibility of can contacting battery terminals which could result in an explosion.

It is in the best interest of both vehicle owner and service technician, to carefully follow the procedures recommended in this manual. Preventative maintenance, applied at recommended intervals, is the best guarantee for keeping the vehicle both dependable and economical.

This vehicle will give years of satisfactory service, providing it receives regular maintenance. Refer to the Periodic Service Schedule for appropriate service intervals (Ref. Fig. 14 on page 12). Refer to Lubrication Points for appropriate lubrication locations (Ref. Fig. 32 on page 21).

CAUTION To prolong vehicle life, some maintenance items must be serviced more frequently on vehicles used under severe driving conditions such as extreme temperatures, extreme dust/debris conditions, frequent use with maximum load.

To access powertrain for routine maintenance, lift or remove seat. For major repair, refer to appropriate Technician's Repair and Service Manual.

Some service procedures may require the vehicle to be lifted. Refer to LIFTING THE VEHICLE for proper lifting procedure and safety information.

SERIAL NUMBER PLATE LOCATION

The serial number, manufacture date code label and supplemental information labels are on the vehicle. One is placed on the body below the front, driver side of the seat. The serial number, manufacture date code label and supplemental information labels located on the chassis under the seat.

Design changes take place on an ongoing basis. In order to obtain correct components for the vehicle, the manufacture date code, serial number and vehicle model must be provided when ordering service parts. The serial number is permanently etched on the frame.

OPERATION AND SERVICE INFORMATION

Read all of manual to become thoroughly familiar with this vehicle. Pay particular attention to all Notes, Cautions and Warnings

PERIODIC SERVICE SCHEDULE

✓ Check ♦ Clean, Adjust, etc. ▲ Replace

To perform service that is listed in this schedule but not described in this manual, contact a local Service Representative or see the Repair and Service Manual for this vehicle.

NOTE: Some maintenance items must be serviced more frequently on vehicles used under severe driving conditions

DAILY

BEFORE USE:

- ✓ Check service brake general operation
- ✓ Check park brake function
- ✓ Check warning device function in reverse
- ✓ Check tire condition
- ✓ Check overall vehicle condition

WEEKLY

TIRES	✓ Examine for cuts, excessive wear and pressure (See GENERAL SPECIFICATIONS)
WHEELS	✓ Check for bent rims, missing or loose lug nuts
FUEL GAUGE	✓ Check for proper operation (at fueling), and fuel cap vent is free of dirt
ENGINE OIL	✓ Check and add if required - DO NOT OVERFILL
STARTER/GENERATOR BELT	✓ Check for tension, wear, cracks

MONTHLY - 20 HOURS (includes items listed in previous table & the following)

WIRING	✓ Check all wiring for loose connections and broken/missing insulation
ACCELERATOR	✓ Check for smooth movement - DO NOT LUBRICATE CABLE
SERVICE BRAKE (MECHANICAL BRAKES) (HYDRAULIC BRAKES IF EQUIPPED)	✓ Conduct brake performance test
PARK BRAKE	✓ Check brake performance and adjust if required
CHOKE CABLE	✓ Check for smooth movement and adjustment - DO NOT LUBRICATE CABLE
CARBURETOR LINKAGE	✓ Check attachment, adjust as required
DIRECTION SELECTOR	✓ Check attachment, adjust as required
ENGINE	✓ Check for unusual noise, vibration, acceleration, oil leaks
COOLING FAN	✓ Check for build-up of foreign matter inside blower housing and fins, clean if required
STEERING ASSEMBLY	✓ Check for abnormal play, tightness of all hardware
TIE ROD/LINKAGES	✓ Check for excessive play, bent components or loose connections
REAR AXLE	✓ Check for leakage, add SAE 30 oil as required

QUARTERLY - 50 HOURS (includes items listed in previous tables & the following)

Fig. 14 Periodic Service Schedule

OPERATION AND SERVICE INFORMATION

Read all of manual to become thoroughly familiar with this vehicle. Pay particular attention to all Notes, Cautions and Warnings

FRONT AXLE	✓ Check for damage to axle and loose or missing hardware
FRONT SHOCK ABSORBERS	✓ Check for oil leakage and loose fasteners
FRONT SPRINGS	✓ Check for loose hardware, cracks at attachments
FRONT WHEEL ALIGNMENT	✓ Check for unusual tire wear, align if required
PARK BRAKE	<ul style="list-style-type: none"> ✓ Check for bent/binding linkage rod ✓ Check for damage or wear to latch arm or catch bracket ◆ Lubricate as required, use light oil. DO NOT LUBRICATE CABLES OR BRAKE LATCH
REAR SHOCK ABSORBERS	✓ Check for oil leakage, loose mounting hardware
ENGINE ELECTRICAL SYSTEM	✓ Check coil/spark plug wires for cracks/loose connections
FUEL SYSTEM	<ul style="list-style-type: none"> ✓ Check for leaks at tank, cap, system lines, filters, pump, carburetor ✓ Check system lines for cracks/deterioration
THROTTLE/GOVERNOR LINKAGE	✓ Check operation and governed speed
HARDWARE AND FASTENERS	<ul style="list-style-type: none"> ✓ Check for loose or missing hardware and components ◆ Tighten or replace missing hardware
SEMI-ANNUAL - 125 HOURS (includes items listed in previous tables & the following)	
BATTERY	◆ Clean battery & terminals
DIRECTION SELECTOR	<ul style="list-style-type: none"> ✓ Check for wear and smooth movement (lubricate shaft with light oil if required) ✓ Check shift cable spring length at rear axle
KING PINS	✓ Check for excessive play and tightness of retaining nuts
STEERING ASSEMBLY	✓ Check bellows and pinion seal for damage or grease leakage
RACK END BALL JOINT	◆ Lubricate, use wheel bearing grease
REAR AXLE	✓ Check for unusual noise and loose or missing mounting hardware
AIR FILTER ELEMENT	✓ Check filter element, clean/replace as required
OIL FILTER	◆ Clean in solvent (at oil change), replace 'O' rings if required
ENGINE OIL	▲ Replace with SAE 10W-30 or 10W-40 that meets or exceeds SF, SG, CC oil, DO NOT OVERFILL
DRIVE BELT	✓ Check for cracks, fraying and excessive wear
ANNUAL - 250-300 HOURS (includes items listed in previous tables & the following)	
FRONT WHEEL BEARINGS	✓ Check and adjust as required, see Technician's Repair and Service Manual
REAR AXLE	✓ Check lubricant, add lubricant (Ref. Fig. 30 on page 20) as required
SERVICE BRAKES (HYDRAULIC BRKES)	<ul style="list-style-type: none"> ◆ Clean and adjust, see Technician's Repair and Service Manual ✓ Check brake shoe linings, see Technician's Repair and Service Manual ✓ Check brake fluid
FUEL FILTER	▲ Replace
SPARK PLUGS	▲ Replace, gap new plugs (Ref. CAPACITIES AND REPLACEMENT PARTS on page 23)

Fig. 14 Periodic Service Schedule

OPERATION AND SERVICE INFORMATION

Read all of manual to become thoroughly familiar with this vehicle. Pay particular attention to all Notes, Cautions and Warnings

MUFFLER/EXHAUST	✓ Check mounting hardware; check for leaks at head and muffler gaskets
VALVES	✓ Check cold (intake/exhaust) per Technician's Repair and Service Manual
500 HOURS (includes items listed in previous tables & the following)	
TIMING BELT	✓ Check tension and for signs of wear/damage, replace if worn or damaged
CARBURETOR	◆ Clean
CYLINDER HEAD AND PISTONS	◆ Remove carbon from cylinder head and pistons ✓ Check valve seats for carbon buildup and clean as required

Fig. 14 Periodic Service Schedule

TIRE INSPECTION

Tire condition should be inspected per the Periodic Service Schedule (Ref. Fig. 14 on page 12). Inflation pressures should be checked when the tires are cool. Be sure to install the valve dust cap after checking or inflating.

CHECKING THE OIL LEVEL

CAUTION Do not overfill engine. Too much oil may cause engine to smoke or spark plug fouling.

NOTE When adding oil between oil changes, do not mix brands and viscosity grades of oil. Both the oil dipstick and fill cap must be in place before operating the engine. Failure to install the dipstick and fill cap will result in oil becoming contaminated and/or oil being discharged into the engine compartment.

The oil should be checked with the engine warm. The vehicle must be on a level surface with the park brake engaged. Allow adequate time for oil to drain into the crankcase before checking.

Remove the dipstick and wipe off the entire area indicated with a lint free cloth (Ref. Fig. 15 on page 14).

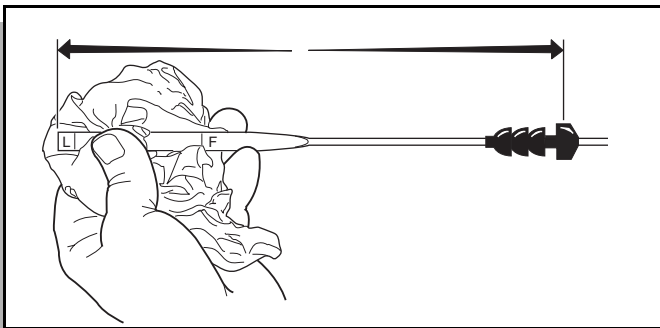

Fig. 15 Clean Entire Dipstick

Insert the dipstick **fully** into the dipstick hole and remove. Examine the level of oil on the dipstick.

The engine can be operated safely as long as oil is within the safe operating range as indicated on the dipstick. **Do not operate vehicle if oil level is below the safe area indicated on the dipstick** (Ref. Fig. 16 on page 14).

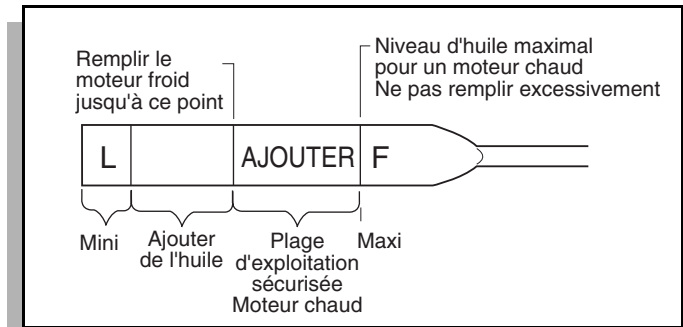

Fig. 16 Check Oil Level on Dipstick

Oil should be added to bring the level into the safe operating range. **Do not overfill.** Check that the oil fill cap and dipstick are firmly in place.

CHANGING THE OIL

Tool List	Qty. Required
Socket, 10 mm, 3/8" drive.....	1
Ratchet, 3/8" drive	1
Extension, 8", 3/8" drive	1
Oil drain pan	1

For maximum performance and longevity, the engine oil should be replaced every 125 hours of operation or semi-annually, whichever comes first.

The selection of oil is dependent upon the service that the vehicle will perform. Most vehicles require 10W-30 oil, whereas vehicles used at capacity or near capacity load applications will require 10W-40 oil after run-in (Ref. Fig. 17 on page 15).

OPERATION AND SERVICE INFORMATION

Read all of manual to become thoroughly familiar with this vehicle. Pay particular attention to all Notes, Cautions and Warnings

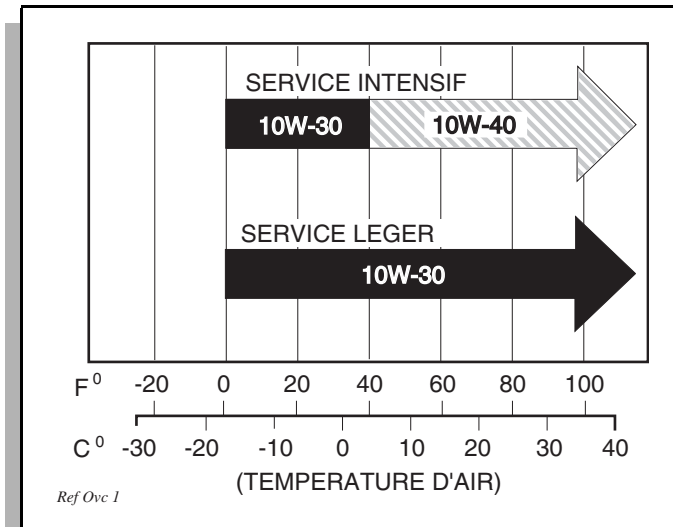

Fig. 17 Oil Viscosity Chart

⚠ WARNING ⚠ *To reduce the possibility of severe injury, wear rubber gloves to protect skin from exposure to hot, used oil and degreaser. These fluids contain chemicals known to cause cancer.*

The oil should be changed with the engine warm. Park the vehicle on a level surface, engage the park brake and remove the key. Place a drain pan under the engine. Wipe the top of the engine clean with a cloth (Ref. Fig. 18 on page 15). Remove the oil fill cap.

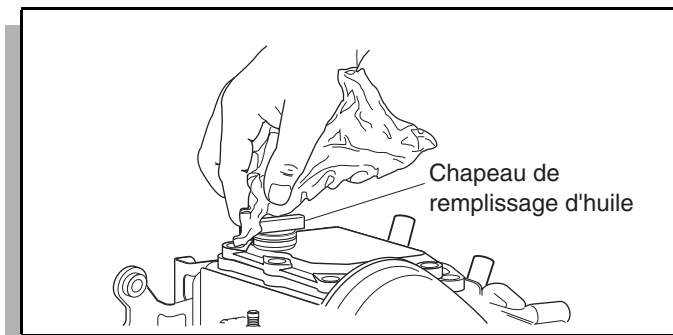

Fig. 18 Clean Top of Engine

Clean the area around the filter. Oil drainage is accomplished by removing the three bolts securing the oil filter to the engine. Remove the filter by pulling it from the engine and allow the oil to drain. The 'O' rings may remain on the engine or the filter (Ref. Fig. 19 on page 15).

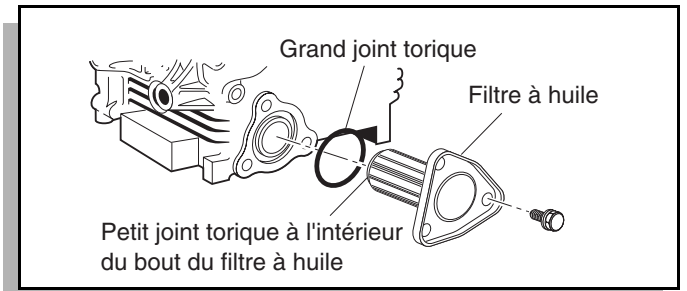

Fig. 19 Remove Oil Filter

At each oil change, thoroughly inspect filter before cleaning. At the first oil change, metal chips and lint may be found. This is normal, resulting from engine run-in. At subsequent oil changes, the presence of metal chips may indicate possible engine damage.



Wear eye protection to reduce the possibility of splashed solvent contacting the eyes when cleaning oil filter.

Clean the filter by washing in any shop degreaser and brushing the metal screen clean with a soft brush (Ref. Fig. 20 on page 15).

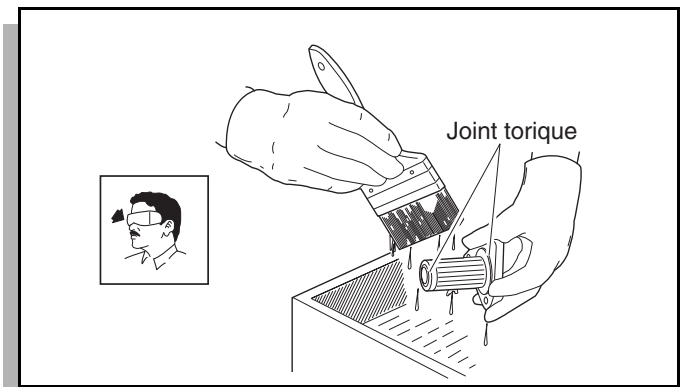

Fig. 20 Clean Oil Filter

Blow out the filter with low pressure air 30 psi (210 kPa) or less from no closer than 3" (8 cm) and allow to air dry (Ref. Fig. 21 on page 16).

Wipe the area around the filter mount with a clean, lint free cloth and inspect both filter 'O' rings for damage; replace if necessary. Install the filter into the engine. The filter engages over a short nipple in the engine. The filter should slide easily onto the nipple and seat against the engine using light hand pressure only. Align the holes in the filter mounting plate with the holes in the engine. Install and hand tighten the bolts before tightening them firmly.

OPERATION AND SERVICE INFORMATION

Read all of manual to become thoroughly familiar with this vehicle. Pay particular attention to all Notes, Cautions and Warnings

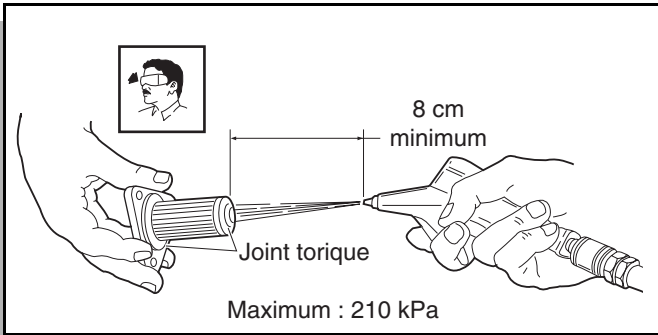

Fig. 21 Blowing Out Oil Filter

Add slightly less than 1 1/2 quarts (1.4 liters) to allow for possible residual oil left in engine (Ref. Fig. 22 on page 16). The oil must be high quality oil that meets or exceeds API SF, SG, CC standards (Ref. Fig. 35 on page 23). Check oil level on dipstick. If necessary, continue to add oil slowly and allow time for oil to flow down into engine. Check oil level on dipstick. **Do not overfill.**

CAUTION Do not overfill engine. Too much oil may cause smoking or allow oil to enter the air filter enclosure.

NOTE Both the oil dipstick and fill cap must be in place before operating the engine. Failure to install the dipstick and fill cap will result in oil being discharged into the engine compartment.

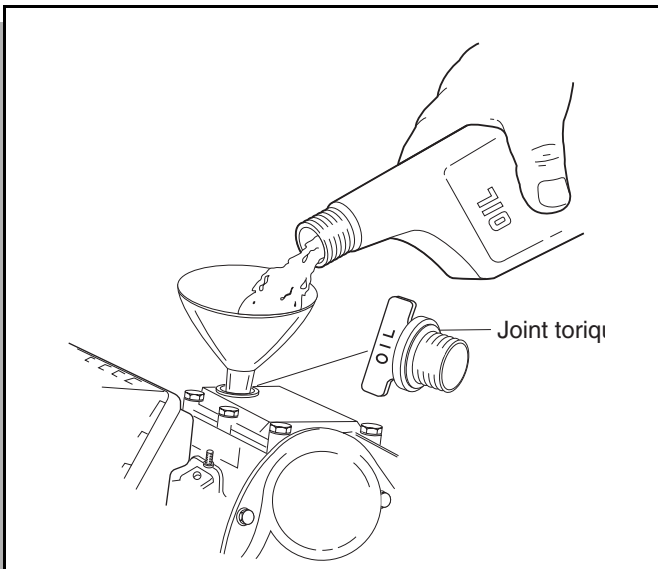

Fig. 22 Add Engine Oil

Inspect oil fill cap 'O' ring and replace if necessary. Install the oil fill cap. Run the vehicle for one or two minutes and check the filter for oil leaks.

Check the oil level again with the vehicle on level ground. Oil should be added to bring the level into the safe operating range. **Do not overfill.** The engine can be operated safely as long as the oil is within the safe operating range as indicated on the dipstick. **Do not operate vehicle if oil level is below the safe area indicated on the dipstick.**

STARTER/GENERATOR BELT TENSION

Tool List	Qty. Required
Belt tension gauge	1
Wrench, 3/4"	1
Wrench, 9/16"	2
Ratchet, 3/8" drive	1
Socket, 3/4", 3/8" drive	1

The starter/generator belt tension should be checked after the first 15 - 20 hours and set to 75 - 80 lbs. (34 - 36 kg).

NOTE A loose belt can cause audible vibration and squeal.

Tighten a **new** starter/generator belt (Ref. Fig. 23 on page 16) to 90 - 110 lbs. (41-50 kg) tension when a gauge is applied half way between the two pulleys (Ref. Fig. 23 on page 16).

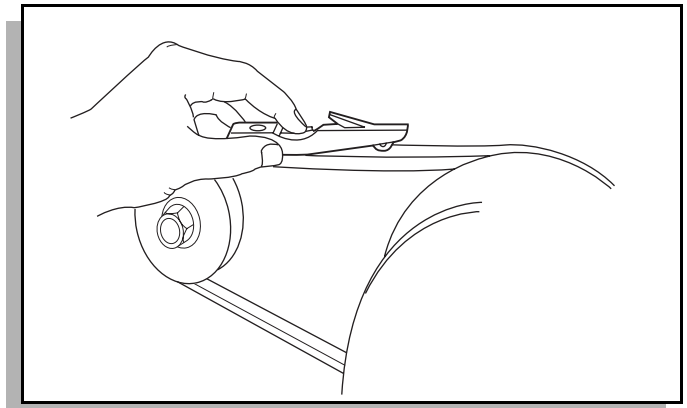

Fig. 23 Checking Belt Tension with Gauge

A **new** belt may be checked manually. A maximum deflection of 3/8" (10 mm) is acceptable (Ref. Fig. 24 on page 17).

Tighten an **existing** belt to 75 - 80 lbs. (34 - 36 kg) tension using the same technique and inspect for cracking or wear. A maximum deflection of 1/2" (13 mm) is acceptable.

OPERATION AND SERVICE INFORMATION

Read all of manual to become thoroughly familiar with this vehicle. Pay particular attention to all Notes, Cautions and Warnings

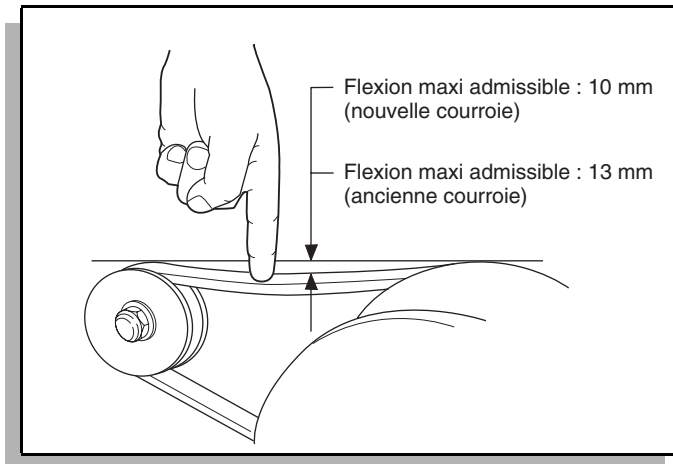

Fig. 24 Checking Belt Tension Manually

Adjusting the Belt

Loosen the starter/generator pivot bolt.

While holding the lower adjusting nut with a wrench, loosen the upper jam nut with another wrench. Move the lower nut up or down the adjustment bolt until proper belt tension is achieved. Hold the lower nut in place and tighten the upper jam nut against it (Ref. Fig. 25 on page 17).

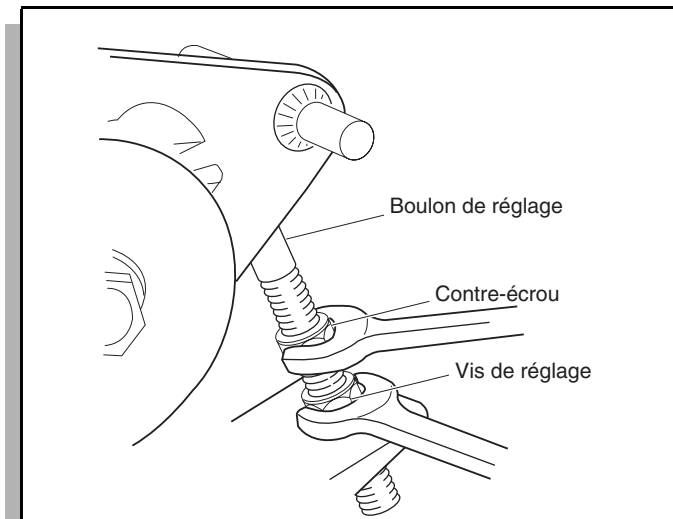

Fig. 25 Adjusting Belt Tension

Tighten the starter/generator pivot bolt.

BATTERY CLEANING

CAUTION To reduce the possibility of damage to vehicle or floor, neutralize acid before rinsing battery.

To reduce the possibility of damage to electrical components while cleaning, do not use a pressure washer.

Cleaning should take place per the Periodic Service Schedule (Ref. Fig. 14 on page 12).

When cleaning the outside of the battery and terminals, first spray with a solution of sodium bicarbonate (baking soda) and water to neutralize any acid deposits before rinsing with clear water.

Use of a water hose without first neutralizing any acid, will move acid from the top of the battery to another area of the vehicle or storage facility where it will attack the metal structure or the concrete/asphalt floor. Additionally, a residue will be left on the battery which is conductive and will contribute to the discharge of the battery.



WARNING To reduce the possibility of battery explosion that could result in severe injury or death, do not use metallic spray wand to clean battery and keep all smoking materials, open flame or sparks away from the battery.

The correct cleaning technique is to spray the top and sides of the battery with a solution of sodium bicarbonate (baking soda) and water. This solution is best applied with a garden type sprayer equipped with a **non metallic spray wand or a plastic spray bottle**. The solution should consist of the amounts of sodium bicarbonate (baking soda) and clear water shown below (Ref. Fig. 26 on page 18). In addition to the battery, special attention should be paid to metal components adjacent to the battery which should also be sprayed with the sodium bicarbonate (baking soda) solution.

Allow the solution to sit for at least three minutes; use a soft bristle brush or cloth to wipe the tops of the battery to remove any residue that could contribute to the self discharge of the battery. Rinse the entire area with low pressure clear water. Do not use a pressure washer.

BRAKES



WARNING To reduce the possibility of severe injury or death, always evaluate pedal travel before operating a vehicle to verify some braking function is present.

All driving brake tests must be done in a safe location with regard for the safety of all personnel.



NOTE Over time, a subtle loss of performance may take place; therefore, it is important to establish

OPERATION AND SERVICE INFORMATION

Read all of manual to become thoroughly familiar with this vehicle. Pay particular attention to all Notes, Cautions and Warnings

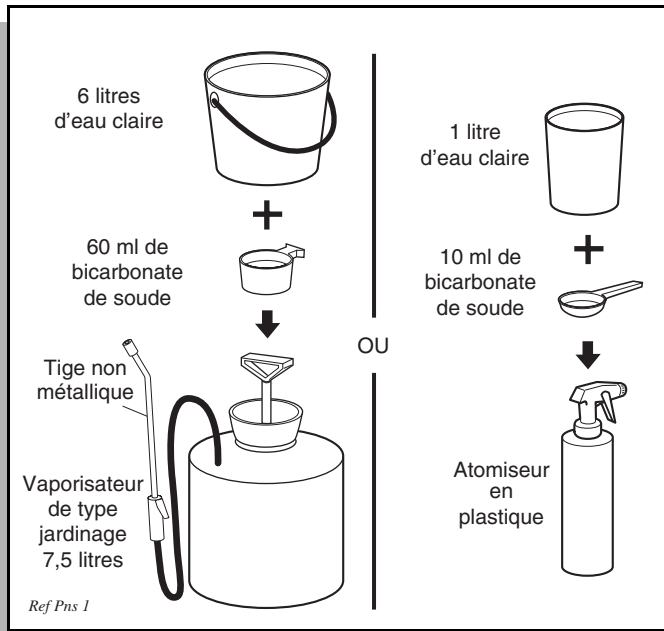

Fig. 26 Preparing Acid Neutralizing Solution

the standard with a new vehicle.

The Periodic Brake Performance Test should be performed regularly (Ref. Fig. 14 on page 12) as an evaluation of braking system performance or if there is a decrease in braking effectiveness. It is useful as a method of identifying subtle loss of performance over time.

Periodic Brake Test for Mechanical Brakes

The purpose of this test is to compare the braking performance of the vehicle to the braking performance of new or 'known to be good' vehicles or to an established acceptable stopping distance. Actual stopping distances will be influenced by weather conditions, terrain, road surface condition, actual vehicle weight (accessories installed) and vehicle speed. No specific braking distance can be reliably specified. The test is conducted by latching the parking brake to eliminate different pedal pressures and to include the affects of linkage mis-adjustment.

Establish the acceptable stopping distance by testing a new or 'known to be good' vehicle and recording the stopping location or stopping distance. For fleets of vehicles, several vehicles should be tested when new and the range of stopping locations or distances recorded.

NOTE Over time, a subtle loss of performance may take place; therefore, it is important to establish the standard with a new vehicle.

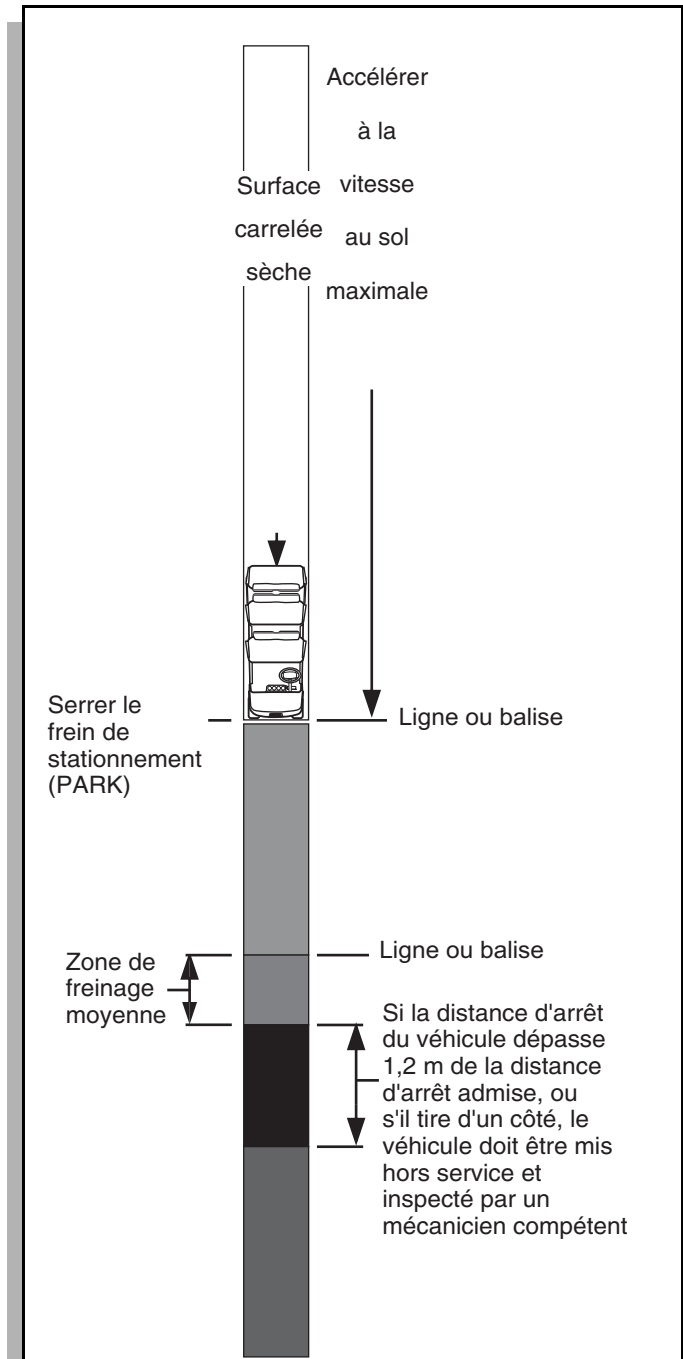

Fig. 27 Typical Brake Performance Test

OPERATION AND SERVICE INFORMATION

Read all of manual to become thoroughly familiar with this vehicle. Pay particular attention to all Notes, Cautions and Warnings

Drive the vehicle at maximum speed on a flat, dry, clean, paved surface (Ref. Fig. 27 on page 18). Quickly depress the brake pedal to latch the parking brake at the line or marker in the test area and remove foot from pedal. The vehicle should stop aggressively. The wheel brakes may or may not lock. Observe the vehicle stopping location or measure the vehicle stopping distance from the point at which the brakes were latched. The vehicle should stop within the 'normal' range of stopping distances. If the vehicle stops more than 4 ft. (1.2 m) beyond the acceptable stopping distance or pulls to one side, the vehicle has failed the test and should be tested again.

If the vehicle fails the second test, it should **immediately** be removed from service. The vehicle **must** be inspected by a qualified mechanic who should refer to the TROUBLESHOOTING section in the Technician's Repair and Service Manual.

Hydraulic Front Disc Brakes (If Equipped)

For vehicles equipped with hydraulic front disc brakes, check master cylinder fluid per PERIODIC SERVICE SCHEDULE or if there is a decrease in braking effectiveness. Inspect components for damage or wear. It is unlikely that fluid will need to be added unless there is a leak in the system. Raise the front of the vehicle (See raising the vehicle). Remove passenger side wheel/tire. Carefully wipe off dirt and debris from master cylinder and cap before opening. Remove the cap. Using a mechanics mirror, check to see that fluid is no more than 1/4" below top of reservoir. Add DOT 3 or 4 fluid as required.

AIR INTAKE AND COOLING FINS

⚠ WARNING ⚠ *To prevent possible burns, engine parts should be kept clean to reduce risk of overheating and ignition of accumulated debris.*

After every off road use, allow to cool and then check for a build up of dirt and debris in the air intake and cooling fins. Dirt and debris may clog the engine's air cooling system. Clean areas shown to prevent engine damage (Ref. Fig. 28 on page 19) (Ref. Fig. 29 on page 19). Keep linkages, springs and controls clean. Keep area around muffler free of any combustible material.

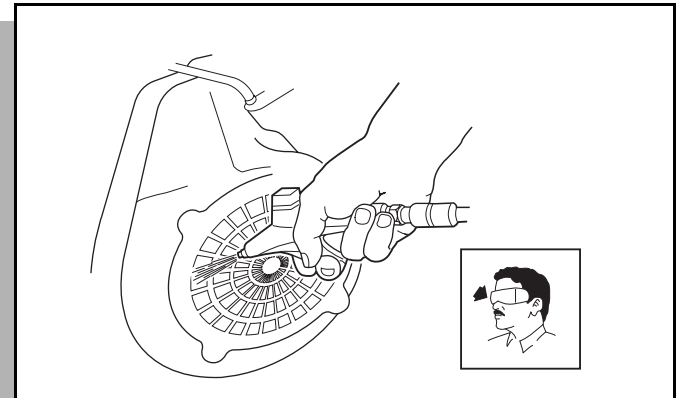

Fig. 28 Cleaning Air Intake

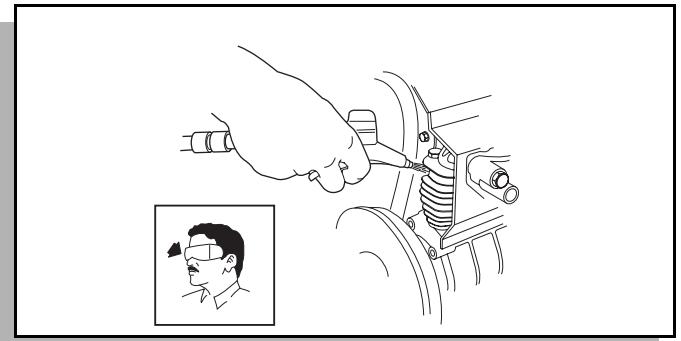

Fig. 29 Cleaning the Cooling Fins

REAR AXLE

The rear axle is provided with a lubricant level check plug located on the driver side at the rear of the housing (Ref. Fig. 30 on page 20). Unless leakage of rear axle lubricant is evident, an annual lubricant check is sufficient.

Checking the Lubricant Level

Tool List	Qty. Required
Socket, 13 mm, 3/8" drive	1
Ratchet, 3/8" drive	1
Funnel	1

Clean the area around the check and fill plugs. Remove the check plug. The correct lubricant level is **just** below the bottom of the threaded hole (Ref. Fig. 30 on page 20). If lubricant is to be added, remove the fill plug and add lubricant using a funnel. Add lubricant slowly until lubricant starts to seep from the check plug hole. Install the check plug and the fill plug. In the event that the lubricant is to be replaced, a drain plug is provided at the bottom of the differential housing.

OPERATION AND SERVICE INFORMATION

Read all of manual to become thoroughly familiar with this vehicle. Pay particular attention to all Notes, Cautions and Warnings

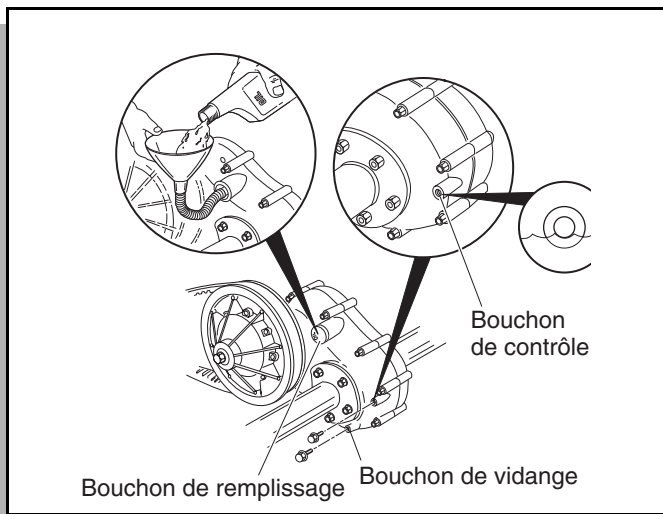

Fig. 30 Add, Check and Drain Rear Axle Lubricant

AIR CLEANER INSPECTION AND REPLACEMENT

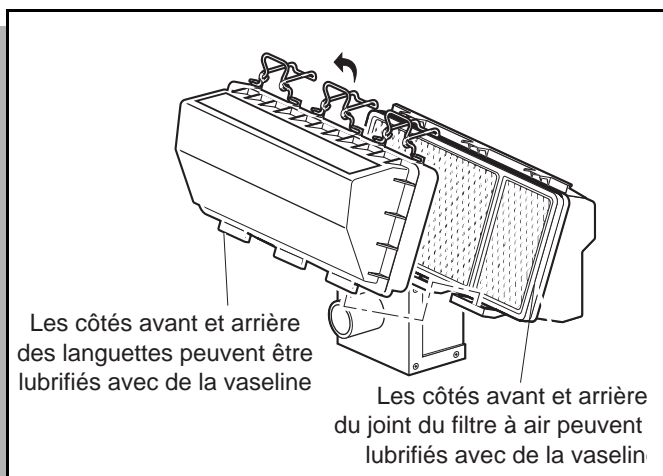

Fig. 31 Air Cleaner

CAUTION To reduce the possibility of engine damage, be sure that bottom tabs of cover are installed in enclosure and top of cover is installed under top tabs. Secure all spring clips.

NOTE The air cleaner unit on the vehicle is a dry unit. Do not use oil on the filter element or any part of the unit. To aide installation and sealing, petroleum jelly may be applied to back side of cover tabs and each side of filter seal.

The air cleaner is attached to the engine and may be accessed by raising the seat. Inspect and replace air filter in accordance with the Periodic Service Schedule (Ref. Fig. 14 on page 12). The air cleaner element is

accessible by unsnapping top clips from the air box and swinging the cover open. **Remove cover and air filter element** (Ref. Fig. 31 on page 20). Clean inside of cover and enclosure. Install the new element in the same way the old filter was removed, being sure that the filter seal is correctly installed. Insert cover into the lower portion of the enclosure and swing it up into place. Squeeze housing together and secure with top clips. Be sure cover fits under tabs and all clips are fastened securely.

Cleaning the Air Filter Element

CAUTION Do not use compressed air to clean the air filter; doing so will damage the filter which may result in damage to the engine.

If the element is in acceptable condition, loose dirt may be removed by tapping the filter lightly. Do not use oil on the filter element or any part of the unit.

LUBRICATION

CAUTION Do not use more than three (3) pumps of grease in any grease fitting at any one time. Excess grease may cause grease seals to fail or grease migration into areas that could damage components.

Putting more than three pumps of grease in a grease fitting could damage grease seals and cause premature bearing failure (Ref. Fig. 32 on page 21).

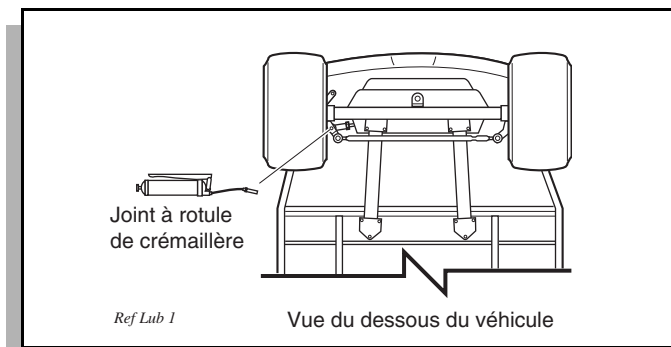

Fig. 32 Lubrication Points

SPARK PLUGS

Tool List	Qty. Required
Spark plug socket, 13/16", 1/2" drive	1
Ratchet, 1/2" drive	1
Plug gauge, wire type	1
Anti-seize compound	AR
Torque wrench, 1/2" drive, ft. lbs.	1

CAUTION Use care not to over-tighten the plug. Over-tightening can cause damage to

OPERATION AND SERVICE INFORMATION

Read all of manual to become thoroughly familiar with this vehicle. Pay particular attention to all Notes, Cautions and Warnings

the aluminum cylinder head threads.

Remove and inspect the spark plugs at intervals indicated in the Periodic Service Schedule (Ref. Fig. 14 on page 12). All new spark plugs should be properly gapped before installation (Ref. Fig. 35 on page 23). Apply a light coat of anti-seize compound and tighten to 18 ft. lbs. (24 Nm) torque.

Fouled spark plugs are indicated by a wet, black appearance. This could be caused by a dirty air filter element or other restrictions in the air intake system. Incorrectly adjusted valves, spark plug wires which are in poor condition or poor quality fuel could also contribute to the problem.

DIRECTION SELECTOR (Dual Cable system)

The direction selector is a mechanical device that operates cables connected to the rear axle. The cables are sealed and do not require lubrication, but may require occasional adjustment (Ref. Fig. 33 on page 21). The factory installed length should be maintained.

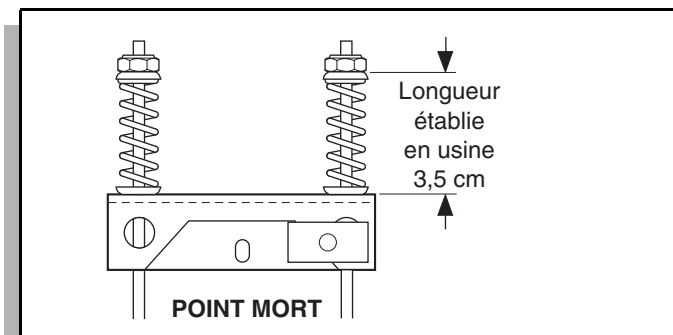

Fig. 33 Shift Cable Adjustment

PROLONGED STORAGE



ble explosion:

Do not handle fuel in an area that is not adequately ventilated. Do not smoke near the fuel tank or refuel near open flame or electrical items which could produce a spark.

Store vehicle in a clean, dry area. Do not store in same area as a stove, furnace, water heater, or other appliance that uses a pilot light or has a device that can create a spark.

When refueling, inspect the fuel cap for leaks or breaks that could result in fuel spillage.

To reduce the possibility of severe injury or death resulting from a possi-

Always wear safety glasses while refueling to prevent possible eye injury from gasoline or gasoline vapor.

Keep hands, clothing and jewelry away from moving parts. Use care not to contact hot objects. Raise the rear of the vehicle and support on jack stands before attempting to run the engine.

Preparing the engine for a prolonged storage period (30 days or more) calls for a few simple steps to prevent a build up of varnish and gum in the carburetor and corrosion in the engine.

- Raise the rear of the vehicle and support on jack stands. Refer to 'Lifting the Vehicle' for proper lifting procedure and safety information.
- Disconnect the fuel hose **at the fuel tank** and plug hose.
- With proper ventilation, depress the accelerator pedal and allow engine to run until it stops due to lack of fuel.
- Remove spark plugs (Refer to SPARK PLUGS on page 21) and pour about 1 oz. (30 ml) of engine oil into each cylinder. Replace spark plugs, ground spark plug wires and use starter to turn engine over a few seconds to distribute oil.
- Add a gasoline additive to the tank in accordance with the manufacturer's recommendations.
- Reattach fuel line to tank and drive the vehicle for several minutes to circulate the additive through the carburetor.
- While engine is still warm, change oil (Refer to CHANGING THE OIL on page 14).
- Clean body, chassis and engine of debris, mud, chaff or grass (Refer to AIR INTAKE AND COOLING FINS on page 19).

HARDWARE

Periodically, the vehicle should be inspected for loose fasteners. Fasteners should be tightened in accordance with the Torque Specifications table (Ref. Fig. 34 on page 22).

Use care when tightening fasteners and refer to the Technician's Repair and Service Manual for specific torque values.

Generally, three grades of hardware are used in the vehicle. Grade 5 hardware can be identified by the three marks on the hexagonal head and grade 8 hardware is identified by 6 marks on the head. Unmarked hardware is Grade 2 (Ref. Fig. 34 on page 22).







OPERATION AND SERVICE INFORMATION

Read all of manual to become thoroughly familiar with this vehicle. Pay particular attention to all Notes, Cautions and Warnings

VALEURS DE COUPLE FT. LBS. (Nm)

A moins d'indication contraire dans le texte, serrer toute la boulonnerie de montage conformément à ce tableau.

Le tableau ci-dessous donne des valeurs de couple à l'état «humide». Les éléments de fixation plaqués ou lubrifiés à l'installation sont dits «humides» et ne demandent que 80 % environ du couple nécessaire aux fixations «sèches».

TAILLE DU BOULON	1/4"	5/16"	3/8"	7/16"	1/2"	9/16"	5/8"	3/4"	7/8"	1"
Qualité 2 	4 (5)	8 (11)	15 (20)	24 (33)	35 (47)	55 (75)	75 (102)	130 (176)	125 (169)	190 (258)
Qualité 5 	6 (8)	13 (18)	23 (31)	35 (47)	55 (75)	80 (108)	110 (149)	200 (271)	320 (434)	480 (651)
Qualité 8 	6 (8)	18 (24)	35 (47)	55 (75)	80 (108)	110 (149)	170 (230)	280 (380)	460 (624)	680 (922)
TAILLE DU BOULON	M4	M5	M6	M8	M10	M12	M14			
Classe 5.8 (Qualité 2) 	1 (2)	2 (3)	4 (6)	10 (14)	20 (27)	35 (47)	55 (76.4)			
Classe 8.8 (Qualité 5) 	2 (3)	4 (6)	7 (10)	18 (24)	35 (47)	61 (83)	97 (131)			
Classe 10.9 (Qualité 8) 	3 (4)	6 (8)	10 (14)	25 (34)	49 (66)	86 (117)	136 (184)			

Ref Tsp 1

Fig. 34 Torque Specifications

OPERATION AND SERVICE INFORMATION

Read all of manual to become thoroughly familiar with this vehicle. Pay particular attention to all Notes, Cautions and Warnings

CAPACITIES AND REPLACEMENT PARTS

Réservoir de carburant	22,5 litres, indice d'octane : 87
Huile moteur	1,4 litre
Filtre à huile	N/P 26591-G01
Filtre à air	N/P 72368-G01
Bougies de préchauffage	NGK BPR5ES (N/P 25523-G4) Espace : 0,71 – 0,76 mm
Courroie de starter/générateur	N/P 26414-G01
Courroie d'embrayage	N/P 72054-G01
Huile d'essieu arrière	1,2 litre
Fusible	15 A (N/P 18392-G1)
Ampoule de phare	#894 (N/P 74004-G01)
Ampoule de feu indicateur	#912 (N/P 74005-G01)
Ampoule de clignotant	#921 (N/P 74006-G01)
Ampoule de feu du hayon	#1157 (N/P 21759-G1)

Ref Cap 4

Fig. 35 Capacities and Replacement Parts

GENERAL SPECIFICATIONS

GENERAL SPECIFICATIONS

SHUTTLE 2 GASOLINE POWERED CARGO CARRIER

WEIGHT (dry fuel tank).....	1000 lbs. (450 kg)
TIRES	18 x 8.50 x 8 (LINKS 4 ply)
TIRE PRESSURE	18 - 22 psi (124 - 152 kPa)
LOAD CAPACITY (including operator, passengers, cargo and accessories)	1200 lbs. (544 kg)
CARGO BED.....	42.5 in. (108 cm) width 32 in. (80 cm) length 12 in. (31 cm) height
CHASSIS	Welded high yield strength tubular steel with Durashield™ Powder Coat paint
BODY & FINISH.....	Durashield™ body of automotive quality injection molded TPE (thermoplastic elastomer). Automotive color coat/clear coat finish
SAFETY	Dash mounted key switch, reverse warning indicator, 'deadman' accelerator control, integral handgrip on hip restraints, manual forward/ reverse selector and electric horn
LIGHTING PACKAGE	Optional Headlights, taillights, brake lights, optional turn signals
BRAKES	Dual rear wheel mechanical, self-adjusting drum brakes. Combination service / park brake with automatic parking brake release (accelerator kick-off). Optional hydraulic front disc brakes
FRONT SUSPENSION	Leaf springs with hydraulic shock absorbers
REAR SUSPENSION.....	Leaf springs with hydraulic shock absorbers
STEERING	Self-compensating single reduction rack and pinion
DASH PANEL.....	Four drink holders of scuff resistant thermoplastic
SEATING.....	Formed, fabric-backed vinyl covers over cushion foam. Seating for two occupants per seat
ENGINE	11 HP (8.2 kw) rated, 4 cycle, 350cc twin cylinder air cooled
VALVE TRAIN	Overhead valve, overhead cam, belt drive
LUBRICATION	Pressurized oil system, washable permanent filter
BALANCER.....	Internal counter rotating balance shaft
IGNITION	Solid state, electronic timing advance and rpm limiter
CARBURETOR.....	Fixed jet float bowl with remote pulse fuel pump
AIR CLEANER	Engine mounted with replaceable dry cartridge element
DRIVE TRAIN	Automatic, continuously variable transmission (CVT), forward and reverse
ELECTRICAL SYSTEM	External starter/generator, solid state regulator, 12 volt maintenance free battery, 360 CCA, 51 minute reserve
TRANSAXLE.....	High efficiency differential with helical gears, 13.32:1 ratio, ground speed governor, forward and reverse
FUEL SYSTEM	6 gallon (22.5 liters) capacity tank with dash mounted electric fuel gauge
SPEED.....	12 - 15 mph (19 - 24 kph)

* Specifications subject to change without notice

GENERAL SPECIFICATIONS

SHUTTLE 6 GASOLINE POWERED PERSONNEL CARRIER

WEIGHT (dry fuel tank).....	1014 lbs. (460 kg)
TIRES	18 x 8.50 x 8 (LINKS 6 ply)
TIRE PRESSURE	18 - 22 psi (124 - 152 kPa)
LOAD CAPACITY (including operator, passengers, cargo and accessories)	1200 lbs. (544 kg)
CHASSIS	Welded high yield strength tubular steel with Durashield™ Powder Coat paint
BODY & FINISH.....	Durashield™ body of automotive quality injection molded TPE (thermoplastic elastomer). Automotive color coat/clear coat finish
SAFETY	Dash mounted key switch, reverse warning indicator, 'deadman' accelerator control, integral handgrip on hip restraints, manual forward/reverse selector and electric horn
LIGHTING PACKAGE	Optional Headlights, taillights, brake lights, optional turn signals
BRAKES	Dual rear wheel mechanical, self-adjusting drum brakes. Combination service / park brake with automatic parking brake release (accelerator kick-off). Optional hydraulic front disc brakes
FRONT SUSPENSION	Leaf springs with hydraulic shock absorbers
REAR SUSPENSION.....	Leaf springs with hydraulic shock absorbers
STEERING.....	Self-compensating single reduction rack and pinion
DASH PANEL.....	Four drink holders of scuff resistant thermoplastic
SEATING.....	Formed, fabric-backed vinyl covers over cushion foam. Seating for two occupants per seat.
ENGINE	11 HP (8.2 kw) rated, 4 cycle, 350cc twin cylinder air cooled
VALVE TRAIN	Overhead valve, overhead cam, belt drive
LUBRICATION	Pressurized oil system, washable permanent filter
BALANCER.....	Internal counter rotating balance shaft
IGNITION.....	Solid state, electronic timing advance and rpm limiter
CARBURETOR.....	Fixed jet float bowl with remote pulse fuel pump
AIR CLEANER	Engine mounted with replaceable dry cartridge element
DRIVE TRAIN	Automatic, continuously variable transmission (CVT), forward and reverse
ELECTRICAL SYSTEM	External starter/generator, solid state regulator, 12 volt maintenance free battery, 360 CCA, 51 minute reverse
TRANSAXLE.....	High efficiency differential with helical gears, 13.32:1 ratio, ground speed governor, forward and reverse
FUEL SYSTEM	6 gallon (22.5 liter) capacity tank with dash mounted electric fuel gauge
SPEED	12 - 15 mph (19 - 24 kph)

* Specifications subject to change without notice

GENERAL SPECIFICATIONS

TG5

GASOLINE POWERED 5 PASSENGER GOLF CAR

WEIGHT (dry fuel tank).....	1014 lbs. (460 kg)
TIRES	18 x 8.50 x 8 (LINKS 4 ply)
TIRE PRESSURE	18 - 22 psi (124 - 152 kPa)
LOAD CAPACITY (including operator, passengers, cargo and accessories)	1200 lbs. (544 kg)
CHASSIS	Welded high yield strength tubular steel with Durashield™ Powder Coat paint
BODY & FINISH.....	Durashield™ body of automotive quality injection molded TPE (thermoplastic elastomer). Automotive color coat/clear coat finish
SAFETY	Dash mounted key switch, reverse warning indicator, 'deadman' accelerator control, integral handgrip on hip restraints, manual forward/reverse selector and electric horn
LIGHTING PACKAGE.....	Optional Headlights, taillights, brake lights, turn signals
BRAKES	Dual rear wheel mechanical, self-adjusting drum brakes. Combination service / park brake with automatic parking brake release (accelerator kick-off). Optional hydraulic front disc brakes
FRONT SUSPENSION.....	Leaf springs with hydraulic shock absorbers
REAR SUSPENSION	Leaf springs with hydraulic shock absorbers
STEERING	Self-compensating single reduction rack and pinion
DASH PANEL	Four drink holders of scuff resistant thermoplastic
SEATING	Formed, fabric-backed vinyl covers over cushion foam. Seating for two occupants per front seat, three per rear seat
ENGINE	11 HP (8.2 kw) rated, 4 cycle, 350cc twin cylinder air cooled
VALVE TRAIN	Overhead valve, overhead cam, belt drive
LUBRICATION	Pressurized oil system, washable permanent filter
BALANCER	Internal counter rotating balance shaft
IGNITION.....	Solid state, electronic timing advance and rpm limiter
CARBURETOR.....	Fixed jet float bowl with remote pulse fuel pump
AIR CLEANER.....	Engine mounted with replaceable dry cartridge element
DRIVE TRAIN	Automatic, continuously variable transmission (CVT), forward and reverse
ELECTRICAL SYSTEM.....	External starter/generator, solid state regulator, 12 volt maintenance free battery, 360 CCA, 51 minute reverse
TRANSAXLE	High efficiency differential with helical gears, 13.32:1 ratio, ground speed governor, forward and reverse
FUEL SYSTEM.....	6 gallon (22.5 liter) capacity tank with dash mounted electric fuel gauge
SPEED.....	12 - 15 mph (19 - 24 kph)

* Specifications subject to change without notice

GENERAL SPECIFICATIONS

SHUTTLE 4
SHUTTLE 6

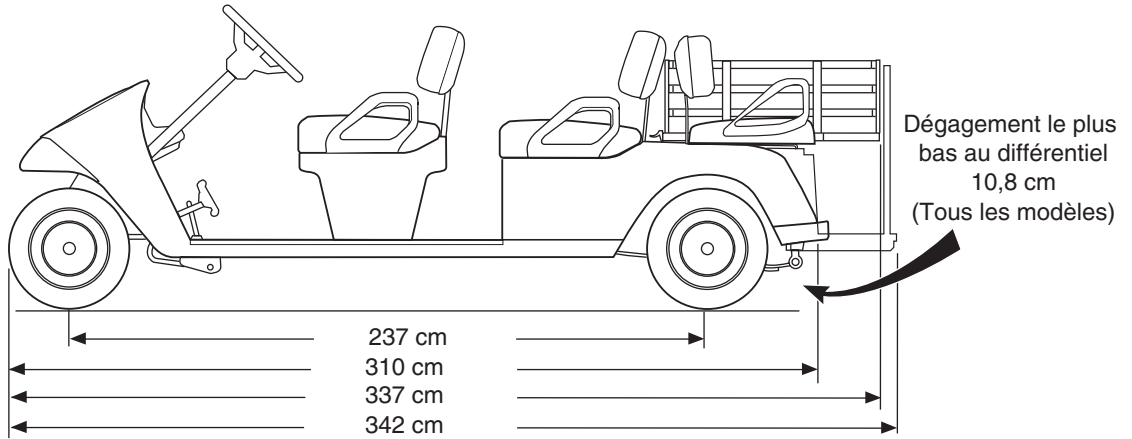

TG5

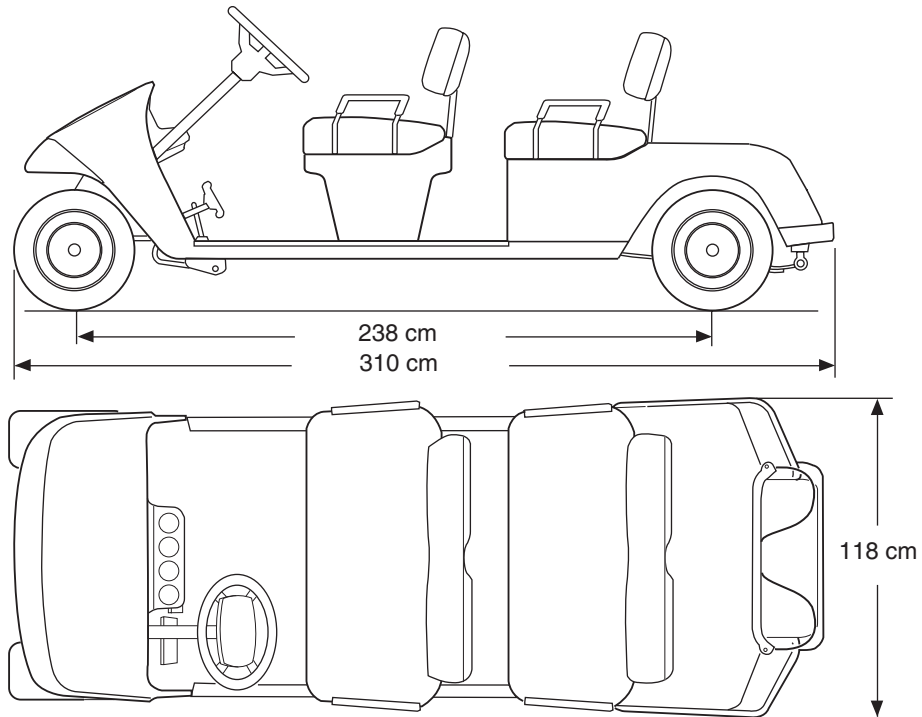

Fig. 36 Vehicle Dimensions

SHUTTLE 2

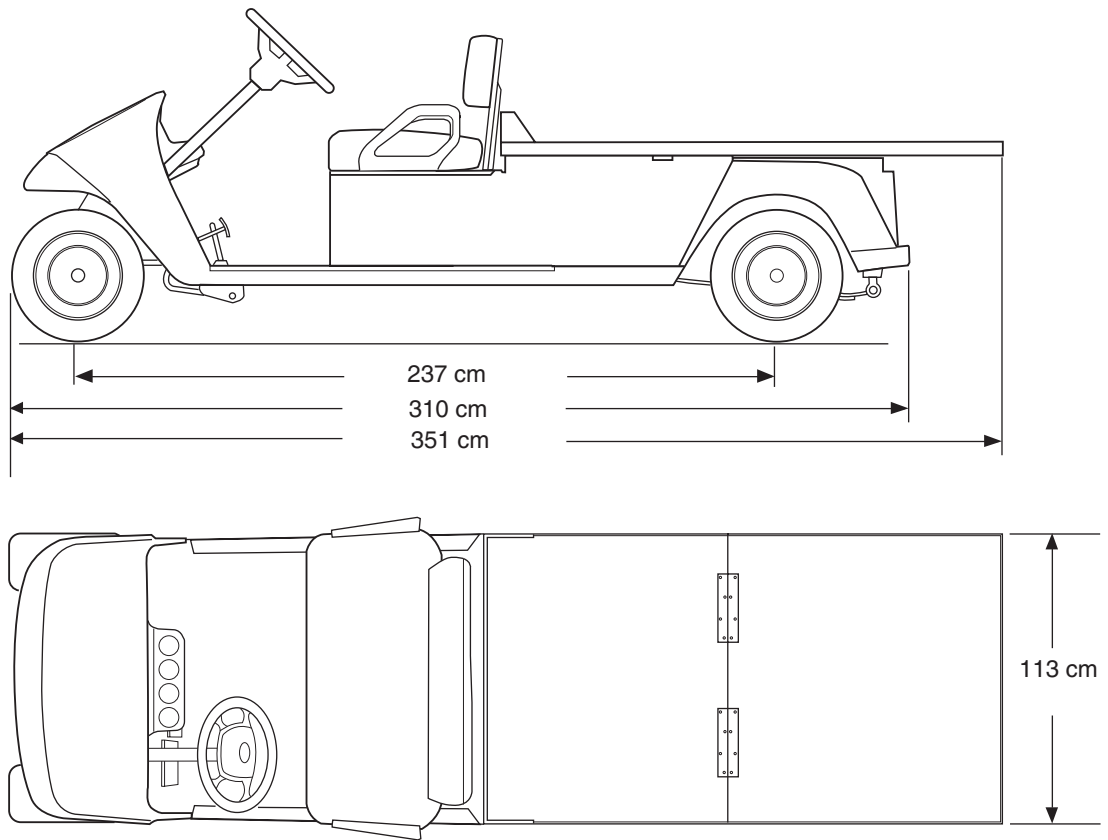

Fig. 37 Vehicle Dimensions

GENERAL SPECIFICATIONS

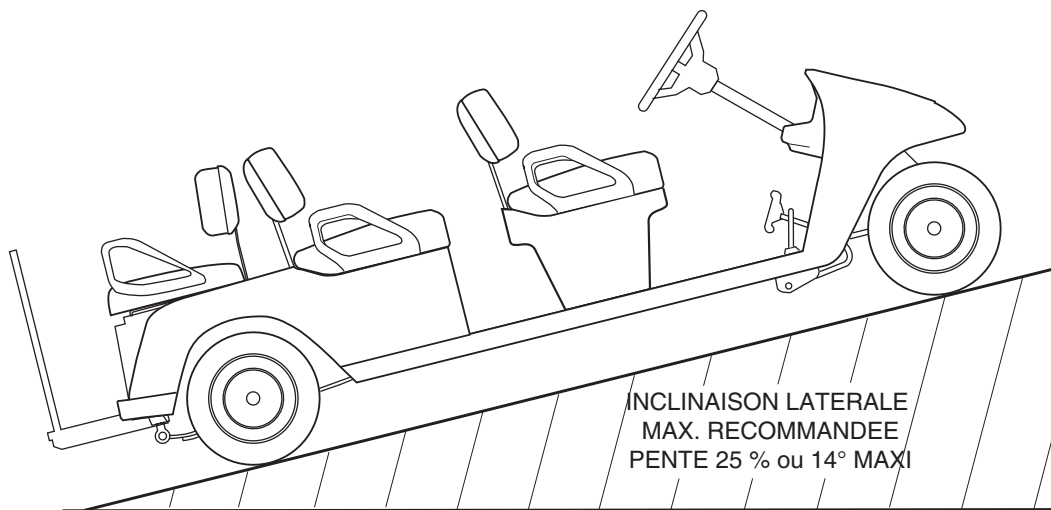
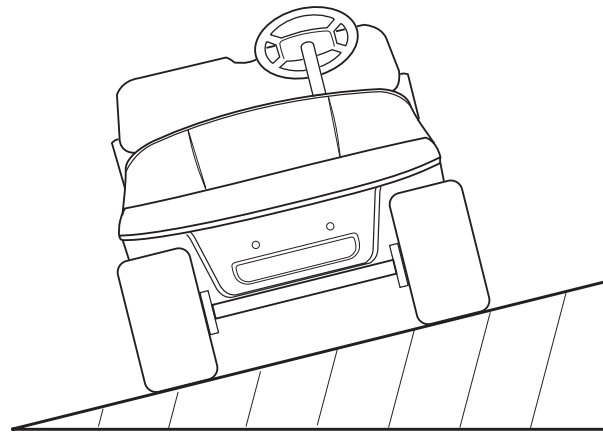
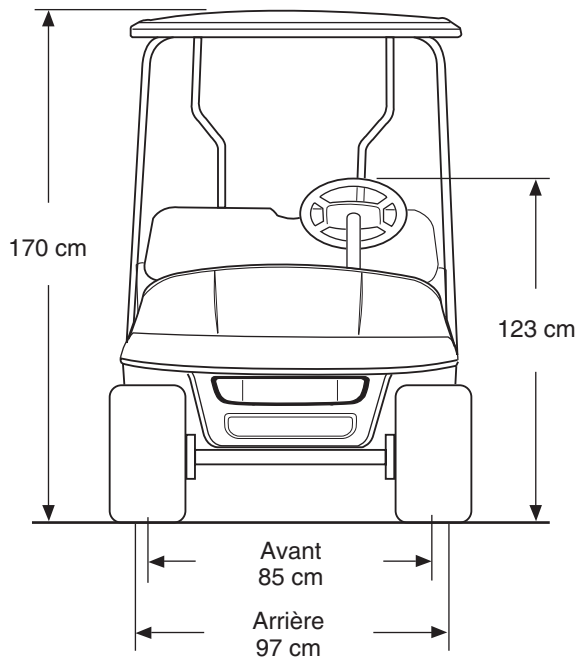

Fig. 38 Vehicle Dimensions and Incline Specifications

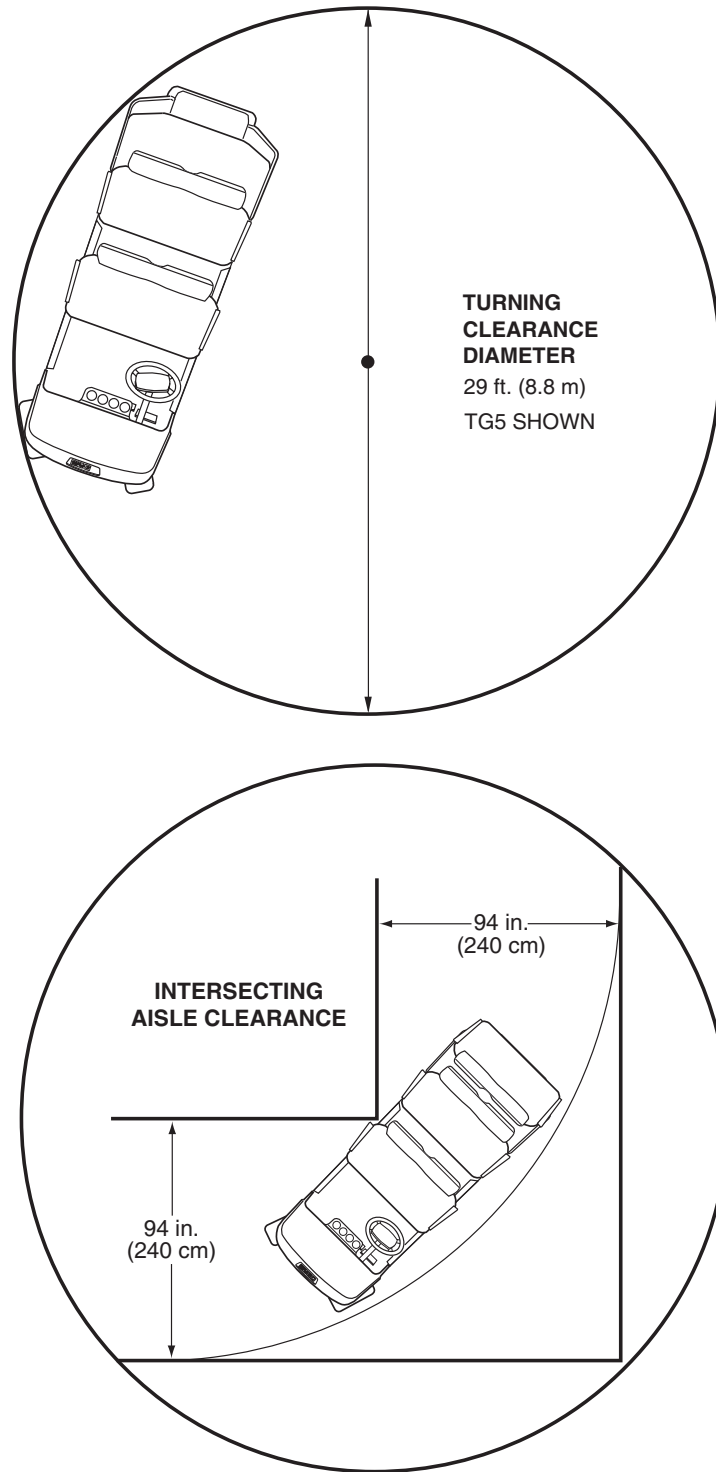

Fig. 39 Vehicle Turning Clearance

VEHICLE WARRANTIES

VEHICLE WARRANTIES

DOMESTIC WARRANTY (U.S. AND CANADA)

To obtain a copy of the limited warranty applicable to the vehicle, call or write a local distributor, authorized Branch or the Warranty Department with vehicle serial number and manufacturer date code.

2004 INTERNATIONAL WARRANTY (ALL COUNTRIES OUTSIDE THE U.S. AND CANADA)

E-Z-GO Division of Textron, Inc. ("E-Z-GO") warrants to the Original Retail Purchaser or the Original Retail Lessee that any 2004 E-Z-GO vehicle and/or Battery Charger shall be free from any defects in material or workmanship for one year from the date of installation at the customer's location with respect to parts and labor.

EXCLUSIONS: Specifically excluded from any E-Z-GO warranty are adjustments/repairs made due to normal wear beyond the first 180 days, routine maintenance items, cosmetic deterioration, and electrical components which are susceptible to fluctuations in current beyond the control of E-Z-GO. This warranty also does not apply to Acts of God or other events over which E-Z-GO has no control. Transportation charges for warranty service, as well as freight charges to receive warranty parts are excluded from this warranty and all replaced parts shall become the property of E-Z-GO. This warranty also excludes batteries, tires, and Lester battery chargers which are warranted by their respective manufacturer.

REMEDY: The sole remedy under this warranty and E-Z-GO's only obligation in the event of a defect in the vehicle/battery charger, is that E-Z-GO will, at its sole option, repair or replace any defective parts. This remedy precludes all other remedies including any lawsuits, claims or other proceedings alleging strict liability, negligence of contract or any cause of action. E-Z-GO reserves the right to improve or change the design of any E-Z-GO vehicle or battery charger without assuming any responsibility to modify previously manufactured vehicles or battery chargers.

DISCLAIMER: THIS WARRANTY IS MADE IN LIEU OF ALL OTHER WARRANTIES, IMPLIED OR EXPRESSED, INCLUDING ANY WARRANTY OF MERCHANTABILITY OR FITNESS FOR A PARTICULAR PURPOSE. TGTSP WILL FURTHER DISCLAIM ANY LIABILITY FOR INCIDENTAL OR CONSEQUENTIAL DAMAGES, TO INCLUDE BUT NOT BE LIMITED TO, PERSONAL INJURY OR PROPERTY DAMAGE ARISING FROM ANY DEFECT IN THE VEHICLE/BATTERY CHARGER.

No agent, employee or representative of E-Z-GO, or any person has any authority to bind E-Z-GO to any other agreement, representation, or warranty concerning the goods sold under this warranty.

WARNING: ANY MODIFICATION OR CHANGE TO THE VEHICLE OR BATTERY CHARGER WHICH ALTERS THE WEIGHT DISTRIBUTION OF THE VEHICLE, ITS STABILITY, INCREASES THE SPEED, OR ALTERS THE OUTPUT OF THE BATTERY CHARGER BEYOND THE FACTORY SPECIFICATION, CAN CAUSE PERSONAL INJURY. DO NOT MAKE ANY SUCH MODIFICATION OR CHANGE. E-Z-GO PROHIBITS, AND DISCLAIMS RESPONSIBILITY FOR, ANY SUCH MODIFICATIONS OR ANY OTHER ALTERATION WHICH WOULD ADVERSELY AFFECT THE SAFETY OF VEHICLE OR BATTERY CHARGER.

VOIDING OF WARRANTY: THIS, AND ANY OTHER WARRANTY SHALL BE VOID IF THE VEHICLE OR BATTERY CHARGER IS ABUSED OR OTHERWISE NOT USED IN ITS INTENDED MANNER; IS IN AN ACCIDENT OR COLLISION; SHOWS INDICATIONS THAT THE SPEED GOVERNOR WAS ADJUSTED OR MODIFIED ALLOWING THE VEHICLE TO OPERATE BEYOND E-Z-GO'S SPECIFICATIONS; SHOWS INDICATIONS THAT IT HAS BEEN ALTERED OR MODIFIED IN ANY WAY FROM E-Z-GO SPECIFICATIONS, INCLUDING BUT NOT LIMITED TO ALTERATIONS TO THE SPEED BRAKING SYSTEM, ELECTRICAL SYSTEM, STEERING OR OTHER OPERATING SYSTEMS OF THE VEHICLE OR; SHOWS INDICATIONS THAT ROUTINE MAINTENANCE WAS NOT PERFORMED WHEN, AND IN THE MANNER SPECIFIED IN THE E-Z-GO MAINTENANCE MANUAL. THIS WARRANTY SHALL BE VOID WITH RESPECT TO ANY DEFECT OR DAMAGE CAUSED BY, OR AS A RESULT OF, OR RELATED TO PARTS OR ACCESSORIES WHICH ARE NOT MANUFACTURED OR AUTHORIZED BY E-Z-GO, OR WERE NOT INSTALLED PER E-Z-GO'S INSTRUCTIONS, OR, FOR GASOLINE VEHICLES, THE USE OF NON-RECOMMENDED FUELS AND LUBRICANTS.

FOR FURTHER INFORMATION, CALL 1-706-798-4311 OR WRITE TO E-Z-GO Division of Textron, Inc. ATTENTION: WARRANTY DEPARTMENT, P.O. BOX 388, AUGUSTA, GEORGIA 30903-0388.

VEHICLE WARRANTIES - FEDERAL (2004)

FEDERAL EMISSIONS COMPONENT DEFECT WARRANTY

EMISSIONS COMPONENT DEFECT WARRANTY COVERAGE - This emission warranty is applicable in all States, except the State of California

Fuji Heavy Industries Ltd. and E-Z-GO Division of Textron Augusta, Georgia, (herein "E-Z-GO") warrant(s) to the initial retail purchaser and each subsequent owner, that this Non-road engine (herein "engine") has been designed, built, and equipped to conform at the time of initial sale to all applicable regulations of the U.S. Environmental Protection Agency (EPA), and that the engine is free of defects in materials and workmanship which would cause this engine to fail to conform with EPA regulations during its warranty period.

For the components listed under PARTS COVERED, the distributor, dealer, or service provider authorized by E-Z-GO will, at no cost to you, make the necessary diagnosis, repair, or replacement necessary to ensure that the engine complies with applicable U.S. EPA regulations.

EMISSION COMPONENT DEFECT WARRANTY PERIOD

The warranty period for this engine begins on the date of sale to the initial purchaser and continues for a period of 2 years.

PARTS COVERED

Listed below are the parts covered by the Emission Components Defect Warranty. Some of the parts listed below may require scheduled maintenance and are warranted up to the first scheduled replacement point for that part.

- 1) Fuel Metering System
 - (i) Carburetor and internal parts (and/or pressure regulator or fuel injection system)
 - (ii) Air/fuel ratio feedback and control system, if applicable.
 - (iii) Cold start enrichment system, if applicable.
 - (iv) Regulator assy (gaseous fuel, if applicable)
- 2) Air Induction System
 - (i) Intake manifold, if applicable
 - (ii) Air filter.
- 3) Ignition System
 - (i) Spark plugs.
 - (ii) Magneto or electronic ignition system.
 - (iii) Spark advance/retard system, if applicable.
- 4) Exhaust manifold, if applicable
- 5) Miscellaneous Items Used in Above Systems
 - (i) Electronic controls, if applicable
 - (ii) Hoses, belts, connectors, and assemblies.
 - (iii) Filter lock assy (gaseous fuel, if applicable)

OBTAINING WARRANTY SERVICE

To obtain warranty service, take your engine to the nearest authorized E-Z-GO distributor, dealer, or service provider. Bring your sales receipts indicating date of purchase for this engine. The distributor, dealer, or service provider authorized by E-Z-GO will perform the necessary repairs or adjustments within a reasonable amount of time and furnish you with a copy of the repair order. All parts and accessories replaced under this warranty become the property of E-Z-GO.

WHAT IS NOT COVERED

- Conditions resulting from tampering, misuse, improper adjustment (unless they were made by the distributor, dealer, or service provider authorized by E-Z-GO during a warranty repair), alteration, accident, failure to use the recommended fuel and oil, or not performing required maintenance services.
- The replacement parts used for required maintenance services.
- Consequential damages such as loss of time, inconvenience, loss of use of the engine or equipment, etc.
- Diagnosis and inspection charges that do not result in warranty-eligible service being performed.
- Any non-authorized replacement part, or malfunction of authorized parts due to use of non-authorized parts.

OWNER'S WARRANTY RESPONSIBILITIES

As the engine owner, you are responsible for the performance of the required maintenance listed in your owner's manual. E-Z-GO recommends that you retain all receipts covering maintenance on your engine, but E-Z-GO cannot

VEHICLE WARRANTIES - FEDERAL (2004)

deny warranty solely for the lack of receipts or for your failure to ensure the performance of all scheduled maintenance.

As the engine owner, you should however be aware that E-Z-GO may deny warranty coverage if your engine or a part has failed due to abuse, neglect, improper maintenance or unapproved modifications.

You are responsible for presenting your engine to the nearest distributor, dealer, or service provider authorized by E-Z-GO when a problem exists.

If you have any questions regarding your warranty rights and responsibilities, you should contact the E-Z-GO Warranty Department at 1-800-241-5855 for the information.

THINGS YOU SHOULD KNOW ABOUT THE EMISSION CONTROL SYSTEM WARRANTY

MAINTENANCE AND REPAIRS

You are responsible for the proper maintenance of the engine. You should keep all receipts and maintenance records covering the performance of regular maintenance in the event questions arise. These receipts and maintenance records should be transferred to each subsequent owner of the engine. E-Z-GO reserves the right to deny warranty coverage if the engine has not been properly maintained. Warranty claims will not be denied, however, solely because of the lack of required maintenance or failure to keep maintenance records.

MAINTENANCE, REPLACEMENT OR REPAIR OF EMISSION CONTROL DEVICES AND SYSTEMS MAY BE PERFORMED BY ANY REPAIR ESTABLISHMENT OR INDIVIDUAL; HOWEVER, WARRANTY REPAIRS MUST BE PERFORMED BY A DISTRIBUTOR, DEALER OR SERVICE PROVIDER AUTHORIZED BY E-Z-GO. THE USE OF PARTS THAT ARE NOT EQUIVALENT IN PERFORMANCE AND DURABILITY TO AUTHORIZED PARTS MAY IMPAIR THE EFFECTIVENESS OF THE EMISSION CONTROL SYSTEM AND MAY HAVE A BEARING ON THE OUTCOME OF A WARRANTY CLAIM.

If other than the parts authorized by E-Z-GO are used for maintenance replacements or for the repair of components affecting emission control, you should assure yourself that such parts are warranted by their manufacturer to be equivalent to the parts authorized by E-Z-GO in their performance and durability.

HOW TO MAKE A CLAIM

All repair qualifying under this limited warranty must be performed by a distributor, dealer, or service provider authorized by E-Z-GO. In the event that any emission-related part is found to be defective during the warranty period, you shall notify E-Z-GO Warranty Department at 1-800-241-5855 and you will be advised of the appropriate warranty service providers where the warranty repair can be performed.

CALIFORNIA EMISSION CONTROL WARRANTY STATEMENT YOUR WARRANTY RIGHTS AND OBLIGATIONS

The California Air Resources Board and Fuji Heavy Industries Ltd. (herein "FUJI") are pleased to explain the emission control system warranty on your 2004 and later small off-road engine (herein "engine"). In California, new engine must be designed, built and equipped to meet the State's stringent anti-smog standards. FUJI must warrant the emission control system on your engine for the period of time described below, provided there has been no abuse, neglect or improper maintenance of your engine.

Your emission control system may include parts such as the carburetor and the ignition system. Also included may be hoses, connectors and other emission-related assemblies.

Where a warrantable condition exists, FUJI will repair your engine at no cost to you including diagnosis, parts and labor.

MANUFACTURER'S WARRANTY COVERAGE:

The 2004 and later engines are warranted for two (2) years. If any emission related part on your engine is defective, the part will be repaired or replaced by FUJI.

OWNER'S WARRANTY RESPONSIBILITIES:

As the engine owner, you are responsible for the performance of the required maintenance listed in your Owner's Manual. FUJI recommends that you retain all receipts covering maintenance on your engine, but FUJI cannot deny warranty solely for the lack of receipts or for your failure to ensure the performance of all scheduled maintenance.

As the engine owner, you should, however, be aware that FUJI may deny you warranty coverage if your engine or a part has failed due to abuse, neglect, improper maintenance or unapproved modifications.

You are responsible for presenting your engine to a dealer, distributor or service provider authorized by E-Z-GO Division of Textron Augusta, Georgia, (herein "E-Z-GO") to which FUJI supplies the engine as soon as a problem exists. The warranty repairs should be completed in a reasonable amount of time, not to exceed 30 days.

If you have any questions regarding your warranty rights and responsibilities, you should contact the E-Z-GO Warranty Department at 1-800-241-5855.

LIMITED WARRANTY on Emission Control Systems - California Only -

FUJI, Tokyo, Japan, warrants to the owner of the 2004 and later engine that the engine (1) has been designed, built and equipped so as to conform at the time of manufacture with the applicable regulations of the California Air Resources Board, and (2) is free from defects in materials and workmanship which could cause it to fail to conform with those regulations as may be applicable in the terms and conditions stated below.

A. WARRANTY COMMENCEMENT DATE

The warranty period begins on the date the engine is delivered to a first retail purchaser.

B. LENGTH OF COVERAGE

FUJI warrants to a first retail purchaser and each subsequent purchaser that the engine is free from defects in materials and workmanship which could cause the failure of a warranted emission-related part for a period of two (2) years after the date of delivery to the first retail purchaser.

C. WHAT IS COVERED:

1. REPAIR OR REPLACEMENT PARTS

Repairs and replacement of any warranted part will be performed at no charge to you by an authorized dealer, distributor or a service provider. You may contact the E-Z-GO Warranty Department at 1-800-241-5855 to get the nearest appropriate location where your warranty repairs are performed.

2. WARRANTY PERIOD

This warranty continues for a period of two (2) years and shall apply only to the repair, replacement or adjustment of the component parts which are not scheduled for replacement as required maintenance. Further, component parts which are scheduled only for regular inspection to the effect of "repair or replace as necessary" shall be warranted for the warranty period. Any warranted

VEHICLE WARRANTIES - CALIFORNIA (2004)

part which is scheduled for replacement as required maintenance shall be warranted for the period of time up to the first scheduled replacement point for that part.

3. DIAGNOSIS

You shall not be charged for diagnostic labor which leads to the determination that a warranted part is defective, if the diagnostic work is performed at an authorized dealer, distributor or service provider.

4. CONSEQUENTIAL DAMAGES

If a warranted part failed causing damages to other engine components, consult a service provider.

D. WHAT IS NOT COVERED

1. This limited warranty does not cover any part which malfunctions, fails or is damaged due to failure to follow the maintenance and operating instructions set forth in the 2004 and later Owner's Manual including:

- (1) improper scheduled engine inspection and maintenance
- (2) improper maintenance of any warranted parts
- (3) improper installation, adjustment or repair of the engine or of any warranted part unless performed by an authorized dealer
- (4) failure to follow recommendations on fuel use contained in the 2004 and later Owner's Manual
- (5) repairs performed outside of the authorized warranty service facilities
- (6) use of parts which are not authorized by FUJI

2. Add-on or modified parts

This warranty does not cover any part which malfunctions, fails or is damaged due to alterations by changing, adding to or removing parts from the engine.

3. Expenses incurred by processing warranty claims

FUJI, any authorized dealer, distributors and service providers shall not be liable for any loss of use of the engine, for any alternative usage, for any damage to goods, loss of time or inconvenience.

E. HOW TO FILE A CLAIM

All repairs qualifying under this Limited Warranty must be performed by a dealer who sold you the engine or distributors or service providers authorized by E-Z-GO. In the event that any emission-related part is found to be defective during the warranty period, you should notify E-Z-GO Warranty Department at 1-800-241-5855 and you will be given the appropriate warranty service facilities where the warranty repair is performed.

F. WHERE TO GET WARRANTY SERVICE

It is recommended that warranty service be performed by the authorized dealer who sold you the engine, although warranty service will be performed by any authorized dealers, distributors and service providers anywhere in the United States. When warranty repair is needed, the engine must be brought to an authorized dealer, distributorship or service provider's place of business during normal business hours. In all cases, a reasonable time, not to exceed 30 days, must be allowed for the warranty repair to be completed after the engine is received by the authorized dealer, distributor or service station.

G. MAINTENANCE, REPLACEMENT AND REPAIR OF EMISSION-RELATED PARTS

Only warranted engine replacement parts approved by FUJI should be used in the performance of any warranty maintenance or repairs on emission-related parts. If other than authorized parts are used for maintenance, replacement or repair of components affecting emission control, you should assure yourself that such parts are warranted by their manufacturer to be equivalent to authorized parts in performance and durability. FUJI, however, assumes no liability under this warranty with respect to parts other than authorized parts. The use of non-authorized replacement parts does not invalidate the warranty on other components unless the non-authorized parts cause damage to warranted parts.

H. PARTS COVERED UNDER THE CALIFORNIA EMISSIONS WARRANTY

(1) Fuel Metering System

- (i) Carburetor and internal parts (and/or pressure regulator or fuel injection system)
- (ii) Air/fuel ratio feedback and control system, if applicable
- (iii) Cold start enrichment system, if applicable
- (iv) Regulator assy (gaseous fuel, if applicable)

(2) Air Induction System

- (i) Intake manifold, if applicable
- (ii) Air filter

(3) Ignition System

- (i) Spark plugs
- (ii) Magneto or electronic ignition system.

VEHICLE WARRANTIES - CALIFORNIA (2004)

- (iii) Spark advance/retard system, if applicable
- (4) Exhaust manifold, if applicable
- (5) Miscellaneous Items Used in Above Systems
 - (i) Electronic controls, if applicable
 - (ii) Hoses, belts, connectors, and assemblies
 - (iii) Filter lock assy (gaseous fuel, if applicable)

I. MAINTENANCE STATEMENTS

It is your responsibility to have all scheduled inspection and maintenance services performed at the times recommended in the 2004 and later Owner's Manual and to retain proof that inspection and maintenance services are performed at the times when recommended. FUJI will not deny a warranty claim solely because you have no record of maintenance; however, FUJI may deny a warranty claim if your failure to perform required maintenance resulted in the failure of warranted part. The proof which you maintain should be given to each subsequent owner of the engine. You are responsible for performing the scheduled maintenance described in the Periodic Service Schedule of this manual. The scheduled maintenance is based on the normal engine operating schedule.

**DECLARATION OF CONFORMITY
(EUROPE ONLY)**

DECLARATION OF CONFORMITY

DECLARATION OF CONFORMITY

**EC Declaration of Conformity • Déclaration de Conformité CE •
EG Conformance-Declaratie • EG-Konformitätsbescheinigung •
Certificato di Conformità CE • EF Konformitetserklæring •
EU Uppfyllandecertifikat • Ilmoitus yhdenmukaisuudesta ey:n sääntöjen kanssa •
Declaración de Conformidad de la CE • Declaração de Conformidade da CE**

We the undersigned • Nous, soussignés • Wij, ondergetekenden • Wir, die Unterzeichnenden • Noi sottoscritti Undertegnede •
Undertecknarna • Me allekirjoittaneet • Los abajo firmantes • Nós, abaixo assinados

Ransomes Jacobsen Limited
West Road, Ransomes Europark,
Ipswich, England, IP3 9TT

Declare that the machine Described Below • Certifions que la machine suivante • verklaren dat onderstaand beschreven machine •
erklären, dass die nachfolgend beschriebene Maschine • Dichiariamo che la macchina descritta di seguito • Erklærer, at følgende maskine •
Deklarerar att den maskin som beskrivs nedan • vahvistamme, että alla kuvattu kone • Certificamos que la máquina descrita abajo •
declaramos que a máquina a seguir descrita

Make & Type • Nom & Type • Merk & Type • Marke und Typ • Marca e tipo •
Fabrikat og type • Fabrikat & typ • Malli ja tyyppi • Marca y Tipo • Marca & Tipo

E-Z-GO
Fleet Golf Car
Freedom, Freedom SE, Freedom LE
Freedom HP, Freedom HP SE
Freedom HP LE, Shuttle 2+2
Gas Shuttle 2, Shuttle 4, Shuttle 6, TG5

Category • Modèle •Categorie • Kategorie • Categoria • Kategori • Luokka •
Categoría • Categoria

**Gasoline Powered Golf Cars, Personal
& Cargo Vehicles**

Series • Série • Serie • Sarja

Starting Model Year: 2001 Onwards

Complies with the provisions of the following European directives and amendments and the regulations transposing it into national law •
Est conforme aux prescriptions des normes, modifications et règles européennes suivantes • voldoet aan de bepalingen van de volgende
Europese Richtlijnen en Amendementen, alsmede aan de verordeningen die deze omzetten in nationale wetgeving • den Bestimmungen der
folgenden Europa-Richtlinien einschließlich aller Änderungen und Ergänzungen sowie den Vorschriften, die diese in das nationale Recht
umsetzen, entspricht • soddísfa quanto previsto dalle seguenti direttive ed emendamenti europei e dalle normative che li riportano in legge
nazionale • Overholder bestemmelserne i følgende EF-direktiver med ændringer og i de forordninger, hvorved de omsættes til national lov •
Uppfyller kraven i följande europeiska direktiv med tillägg och regler transponerade till nationell lagstiftning • täyttää seuraavana mainittujen
Euroopan direktiivien ja muutosten ja säännösten asettamat edellyt

Machinery Safety Directive • Directive de sécurité des machines • Richtlijn Machineveiligheid • Richtlinie zur Maschinensicherheit •
Direttiva sulla sicurezza del macchinario • Maskinsikkerhedsdirektivet • Maskinsäkerhetsdirektiv • Koneen turvallisuutta koskeva direktiivi •
Directiva de seguridad de maquinaria • Directiva de segurança de máquinas **98/37/EC**

EMC Directive • Directive de compatibilité électromagnétique • EMC Richtlijn •
EMK-Richtlinie • Direttiva EMC • EMC-direktivet • Elektromagnetiskt kompatibilitetsdirektiv •
EMC-direktiivi • Directiva EMC **89/336/EEC**
92/31/EEC

Battery & Accumulator Directive • Directive de pile et Accumulateur • Batterij en Opstapelaar Richtlijn • Batterie und Speicherdirektive •
La Direttiva di batteria ed Accumulator • Directiva de batería y Acumulador • **91/157/EEC**

Keeper of Technical File, Place & Date of Declaration • Lieu & Date de déclaration • Plaats & datum verklaringsaflegging • Ort und Datum
dieser Erklärung • Luogo e data della dichiarazione • Sted og dato for erklæringen • Plats & datum för deklaration • Lausunnon paikka ja
päivämäärä • Lugar y fecha de la declaración • Local e data da declaração

Mangaing Director Jacobsen International
Ransomes Jacobsen Limited
West Road, Ransomes Europark,
Ipswich, England, IP3 9TT

01.08.2005



S. Chicken
Mangaing Director Jacobsen International











Certificate Number • Numéro du certificat • Certificaatnummer • Zertifikat Nummer •
Numero certificato • Zertifikatnummer • Zertifikat nummer • Zertifikaatnumero •
Número de certificado • Número do Certificado

Gasoline Powered Golf Cars & Personal Vehicles(Rev0)

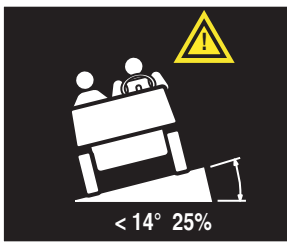

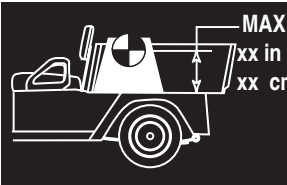
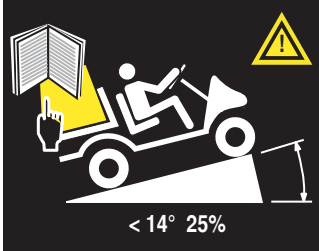



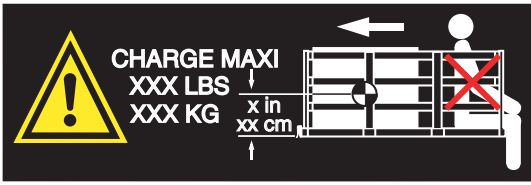
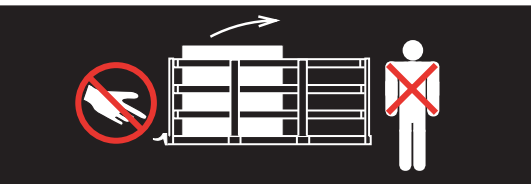















LABELS AND PICTOGRAMS

LABELS AND PICTOGRAMS

1.  **AVERTISSEMENT**
2.  **LIRE LE MANUEL**
3.  **AVERTISSEMENT
ATTENTION AU
MAUVAIS TEMPS**
4.  **AVERTISSEMENT
NE PAS UTILISER SOUS
L'INFLUENCE D'ALCOOL
OU DE MEDICAMENTS**
5.  **ANGLE MAXIMUM A
FLANC DE COLLINE /
EN COTE SELON
SPECIFICATIONS**
6.  **AVERTISSEMENT
ANGLE MAXIMUM A FLANC
DE COLLINE / EN COTE :
SELON SPECIFICATIONS**
7.  **CHARGE AU
CENTRE DE
GRAVITE ELEVE
RISQUE DE RENSER
LE VEHICULE**
8.  **CENTRE DE
GRAVITE DE
CHARGE,
HAUTEUR MAXI**
9.  **AVERTISSEMENT
POUR LA CAPACITE
MAXIMALE DE LA ZONE
DE CHARGEMENT ET
POUR LES COTES,
VOIR LE MANUEL**
10.  **FIXER LA CHARGE LE
PLUS EN AVANT
POSSIBLE. CAPACITE
MAXIMALE DE LA ZONE
DE CHARGEMENT**
11.  **NE PAS SE TENIR DANS
LA ZONE DE CHARGEMENT
LORSQUE LE VEHICULE
SE DEPLACE**
12.  **RISQUE D'EXPLOSION
NE PAS REMPLIR DE
RESERVOIR D'ESSENCE
DANS LA ZONE
DE CHARGEMENT**
13.  **AVERTISSEMENT
CHARGE MAXI ET
CENTRE DE GRAVITE.
PLACER LA CHARGE LE
PLUS EN AVANT
POSSIBLE. NE PAS
SE TENIR DANS LA ZONE
DE CHARGEMENT
LORSQUE LE VEHICULE
SE DEPLACE.**
14.  **ELOIGNER LES MAINS
ET LES DOIGTS DE
LA ZONE DE
CHARGEMENT ET NE
PAS SE TENIR
DERRIERE CELLE-CI**













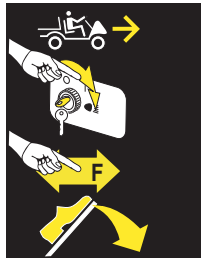

Ref Pic 1-1

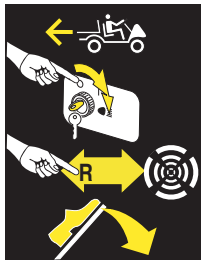
LABELS AND PICTOGRAMS

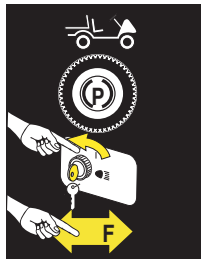
- | | | | | | |
|-----|---|---|-----|---|---|
| 15. |  | <p>NETTOYER LES DEVERSEMENTS D'ESSENCE AVEC DE L'EAU, AVANT DE METTRE LE MOTEUR EN MARCHÉ</p> | 27. |  | <p>ELOIGNER DES FLAMMES</p> |
| 16. |  | <p>ESSENCE SANS PLOMB</p> | 28. |  | <p>NE PAS JETER LES BATTERIES DANS LES POUBELLES</p> |
| 17. |  | <p>NE PAS RENSERER D'ESSENCE SUR UN MOTEUR CHAUD</p> | 29. |  | <p>NE PAS CONDUIRE SUR AUTOROUTES</p> |
| 18. |  | <p>POMPE DE CARBURANT AU SOL</p> | 30. |  | <p>LE PARE-BRISE N'OFFRE AUCUNE PROTECTION CONTRE DES PROJECTILES</p> |
| 19. |  | <p>BASSE PRESSION D'HUILE</p> | 31. |  | <p>LES BATTERIES SONT LOURDES. ATTENTION AU LEVAGE</p> |
| 20. |  | <p>BATTERIE A TERRE NEGATIVE</p> | 32. |  | <p>UTILISER DES OUTILS ISOLES</p> |
| 21. |  | <p>NE PAS METTRE LA BORNE POSITIVE DE LA BATTERIE A LA TERRE</p> | 33. |  | <p>PORTER DES LUNETTES DE PROTECTION</p> |
| 22. |  | <p>LA MISE EN COURT-CIRCUIT DE LA BATTERIE RISQUE DE PROVOQUER UNE EXPLOSION</p> | 34. |  | <p>INTERDICTION DE FUMER</p> |
| 23. |  | <p>MANIPULATION INTERDITE. NE PAS TOUCHER</p> | 35. |  | <p>SURFACE CHAUDE</p> |
| 24. |  | <p>AVERTISSEMENT CORROSIF</p> | | | |
| 25. |  | <p>AVERTISSEMENT EXPLOSIF</p> | | | |
| 26. |  | <p>AVERTISSEMENT TENSION MORTELLE</p> | | | |

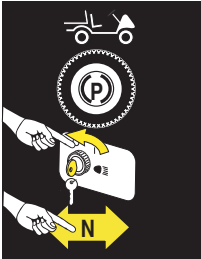
Ref Pic 1-2

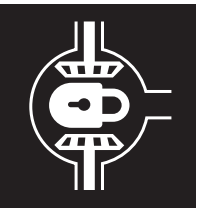
LABELS AND PICTOGRAMS

- | | | | | | |
|-----|---|---|-----|--|--|
| 36. |  | <p>UTILISER COTE
CONDUCTEUR SEULEMENT</p> | 42. |  | <p>RISQUE DE COINCEMENT.
ELOIGNER LES MAINS</p> |
| 37. |  | <p>NE PAS SE PENCHER
EN DEHORS DU VEHICULE</p> | 43. |  | <p>POSITION
'MARCHE'</p> |
| 38. |  | <p>POUR UTILISER LE VEHICULE EN
MARCHE AVANT :
* PLACER LA CLE SUR 'MARCHE'
* PLACER LE SELECTEUR DE
DIRECTION SUR 'MARCHE AVANT'
* APPUYER SUR LA PEDALE
D'ACCELERATEUR ET ACCELERER
DOUCEMENT</p> | 44. |  | <p>POSITION
'ARRET'</p> |
| 39. |  | <p>POUR UTILISER LE VEHICULE EN
MARCHE ARRIERE
* PLACER LA CLE SUR 'MARCHE'
* PLACER LE SELECTEUR DE
DIRECTION SUR 'MARCHE ARRIERE'
* UN SIGNAL SONORE RETENTIT
* APPUYER SUR LA PEDALE
D'ACCELERATEUR ET ACCELERER
DOUCEMENT</p> | 45. |  | <p>PHARES</p> |
| 40. |  | <p>POUR GARER UN VEHICULE A
ESSENCE :
* SERRER LE FREIN DE STATIONNEMENT
* PLACER LA CLE SUR 'ARRET'
* PLACER LE SELECTEUR DE
DIRECTION SUR 'MARCHE AVANT'</p> | 46. |  | <p>OUVERT</p> |
| 41. |  | <p>POUR GARER UN VEHICULE
ELECTRIQUE :
* SERRER LE FREIN DE
STATIONNEMENT
* PLACER LA CLE SUR 'ARRET'
* PLACER LE SELECTEUR DE
DIRECTION AU 'POINT MORT'</p> | 47. |  | <p>FERME</p> |
| | | | 48. |  | <p>DIFFERENTIEL
BLOQUE</p> |
| | | | 49. |  | <p>AVERTISSEMENT
NE PAS SE PENCHER
EN DEHORS DU VEHICULE</p> |
| | | | 50. |  | <p>AVERTISSEMENT
RISQUE D'ARC
ELECTRIQUE OU
D'EXPLOSION DE LA
BATTERIE. PORTER
DES LUNETTES DE
PROTECTION</p> |

Ref Pic 1-3

LABELS AND PICTOGRAMS

51.

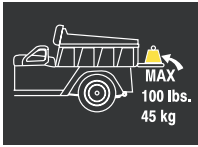

CHARGE
MAXIMALE
DU HAYON

52.



APPUYER SUR
LA PEDALE

53.

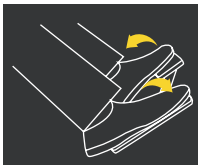

RELACHER
ET APPUYER
SUR LA PEDALE

Ref Pic 1-4

NOTE

Read and understand the following warnings before attempting to operate the vehicle:



To prevent personal injury or death, observe the following:

When vehicle is to be left unattended, engage parking brake, move direction selector to 'F' (forward) position, turn key to 'OFF' position and remove key.

Drive vehicle only as fast as terrain and safety considerations allow. Consider the terrain and traffic conditions. Consider environmental factors which effect the terrain and the ability to control the vehicle.

Avoid driving fast down hill. Sudden stops or change of direction may result in a loss of control. Use service brake to control speed when traveling down an incline.

Use extra care and reduced speed when driving on poor surfaces, such as loose dirt, wet grass, gravel, etc.

All travel should be directly up or down hills.

Use extra care when driving the vehicle across an incline.

Stay in designated areas and avoid steep slopes. Use the parking brake whenever the vehicle is parked.

Keep feet, legs, hands and arms inside vehicle at all times.

Avoid extremely rough terrain.

Check area behind the vehicle before operating in reverse.

Make sure the direction selector is in correct position before attempting to start the vehicle.

Slow down before and during turns. All turns should be executed at reduced speed.

Always bring vehicle to a complete stop before shifting the direction selector.

See GENERAL SPECIFICATIONS for vehicle load and seating capacity.

NOTE

Read and understand the following text and warnings before attempting to service vehicle:

In any product, components will eventually fail to perform properly as the result of normal use, age, wear or abuse. It is virtually impossible to anticipate all possible component failures or the manner in which each component may fail.

Be aware that a vehicle requiring repair indicates that the vehicle is no longer functioning as designed and therefore should be considered potentially hazardous. Use extreme care when working on any vehicle. When diagnosing, removing or replacing any components that are not operating correctly, take time to consider the safety of yourself and others around you should the component move unexpectedly.

Some components are heavy, spring loaded, highly corrosive, explosive or may produce high amperage or reach high temperatures. Gasoline, carbon monoxide, battery acid and hydrogen gas could result in serious bodily injury to the technician/mechanic and bystanders if not treated with the utmost caution. Be careful not to place hands, face, feet or body in a location that could expose them to injury should an unforeseen situation occur.

Always use the appropriate tools listed in the tool list and wear approved safety equipment.



Before working on the vehicle, remove all jewelry (rings, watches,

necklaces, etc.)

Be sure that no loose clothing or hair can contact moving parts.

Use care not to touch hot objects.

Raise rear of vehicle and support on jack stands before attempting to run or adjust powertrain.

Wear eye protection when working on or around vehicle. In particular, use care when working around batteries, using solvents or compressed air.

Hydrogen gas is formed when charging batteries. Do not charge batteries without adequate ventilation.

Do not permit open flame or anyone to smoke in an area that is being used for charging batteries. A concentration of 4% hydrogen gas or more is explosive.

Engine exhaust gas (carbon monoxide) is deadly. Carbon monoxide is an odorless, colorless gas that is formed as a natural part of incomplete combustion of hydrocarbon fuels. Carbon monoxide is a dangerous gas that can cause unconsciousness and is potentially lethal.

The following are symptoms of carbon monoxide inhalation:

- Dizziness
- Vomiting
- Intense Headache
- Muscular Twitching
- Weakness and Sleepiness
- Throbbing in Temples

If any of these symptoms are experienced, get fresh air immediately. Never work around or operate a vehicle in an environment that does not ventilate exhaust gases from the area.



A Textron Company

1451 Marvin Griffin Road, Augusta, Georgia 30906 - 3852 USA
Inside USA Phone: 1-800-241-5855, FAX: 1-800-448-8124
Outside USA Phone: 010-1-706-798-4311, FAX: 010-1-706-771-4609

Copyrighted Material
This manual may not be reproduced in whole or
in part without the express permission of
E-Z-GO Division of Textron Inc.
Technical Communications Department